

ALPHA1



Further product
documentation



net.grundfos.com/qr/i/98500744



DE: Warnung

Dieses Produkt können Kinder ab acht Jahren und Personen mit eingeschränkten körperlichen, sensorischen oder geistigen Fähigkeiten sowie Personen mit mangelnder Erfahrung bzw. fehlendem Wissen in Bezug auf das Produkt nur dann verwenden, wenn sie dabei beaufsichtigt werden oder eindeutige Anweisungen über die sichere Verwendung des Produkts erhalten haben. Diese Personen müssen auch die mit der Verwendung des Produkts verbundenen Gefahren verstehen. Erlauben Sie niemals Kindern, mit dem Produkt zu spielen. Die Reinigung und Wartung darf nicht

von Kindern oder Personen mit eingeschränkten körperlichen, sensorischen oder geistigen Fähigkeiten durchgeführt werden, wenn sie dabei nicht entsprechend beaufsichtigt werden.

FR: Avertissement

Ce produit peut être utilisé par des enfants de 8 ans et plus, ainsi que par des personnes présentant des troubles physiques, sensoriels ou mentaux, ou manquant d'expérience et de connaissances sur le produit. Ces personnes doivent cependant l'utiliser sous surveillance ou avoir été formées à l'utilisation du produit. Elles doivent être en mesure de comprendre les dangers impliqués

lors de l'utilisation du produit. Ne jamais laisser les enfants jouer avec le produit. Les enfants ou des personnes présentant des troubles physiques, sensoriels ou mentaux ne peuvent pas s'occuper du nettoyage ou de la maintenance sans surveillance.

IT: Avvertimento

Questo prodotto può essere utilizzato da bambini di almeno 8 anni e da persone con ridotte capacità fisiche, sensoriali o mentali o con mancanza di esperienza e competenza purché siano sorvegliati o abbiano ricevuto istruzioni sull'utilizzo sicuro dell'apparecchio. Tali persone devono inoltre comprendere i rischi connessi all'uso del prodotto. Impedire ai bambini di giocare con il prodotto. La pulizia e la manutenzione utente non

devono essere effettuate da bambini o persone con ridotte capacità fisiche, sensoriali o mentali senza un'adeguata sorveglianza. fisiche, sensoriali o mentali ridotte non devono utilizzare questo prodotto a meno che non siano state istruite o siano sotto la supervisione di un responsabile. I bambini non devono utilizzare o giocare con questo prodotto.



Max. 95 % RH
IP42



Min./Max.
+2 °C / +110 °C



Min./Max.
0 °C / +40 °C



< 43 dB(A)

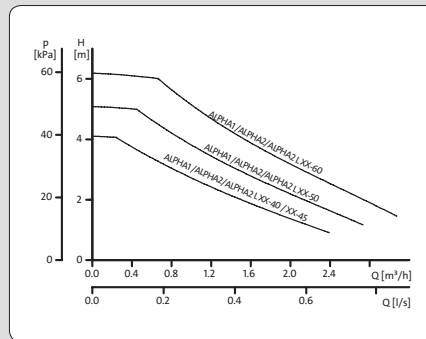

Max. 1.0 MPa
(10 bar)

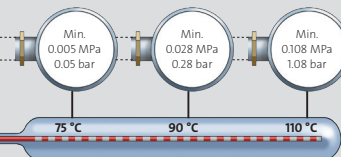



1

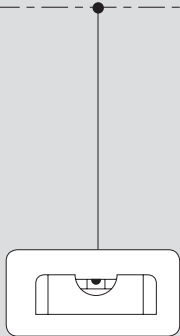
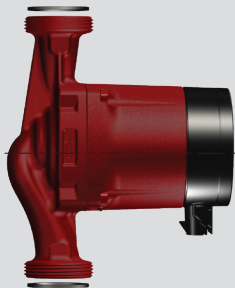
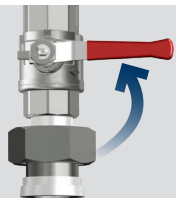

i



i

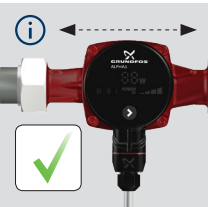

i



2

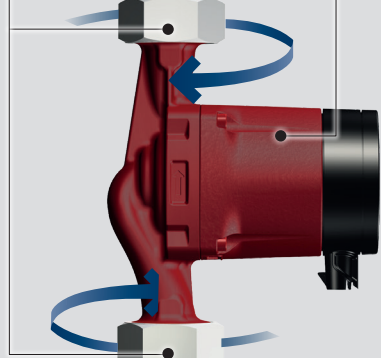
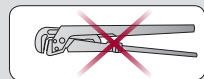
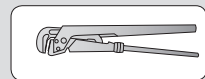

i



i

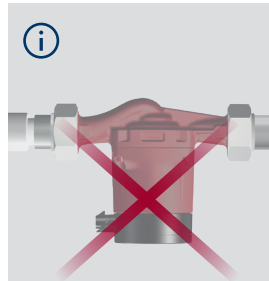

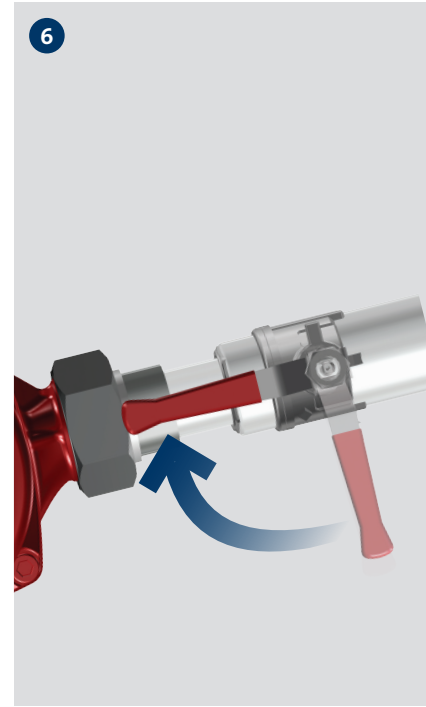
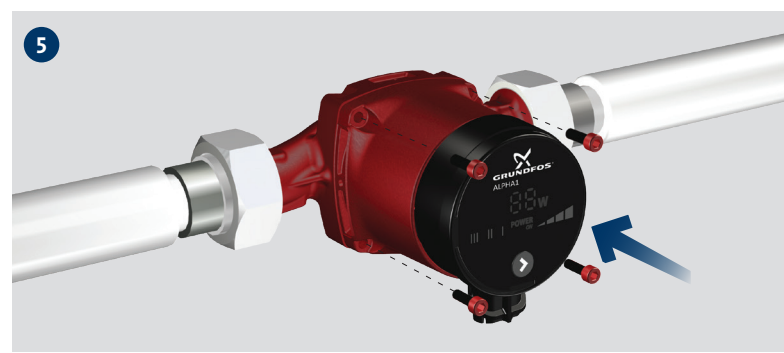
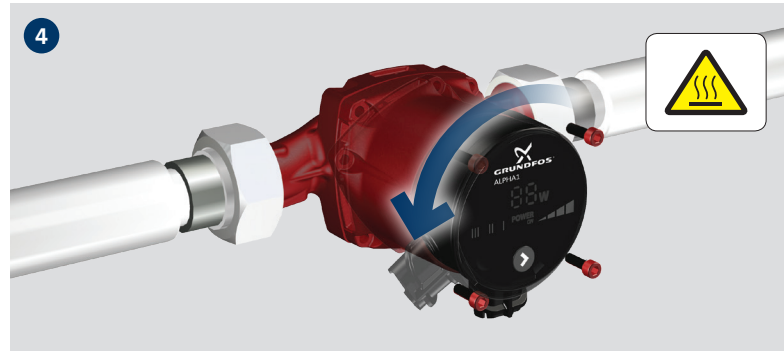
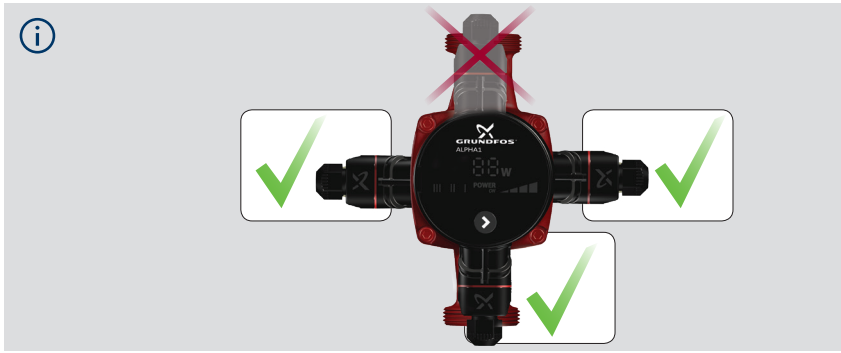



7



7 mm

12 mm
17 mm0.5 - 1.5 mm²

Ø 5.5 - 10 mm

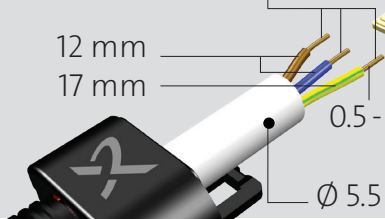

8

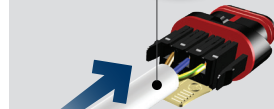
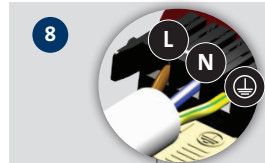

9



13



14

1 x 230 V ± 10 %
~ 50/60 Hz

RCD TYPE A

10

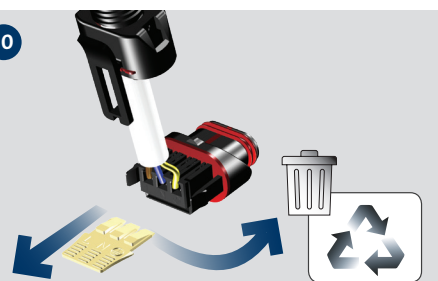

11

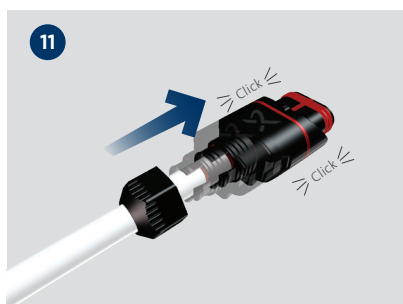

12

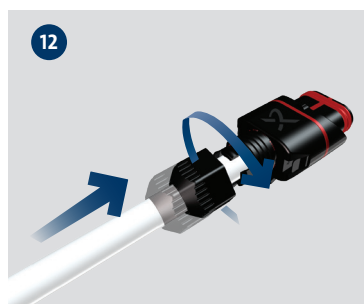

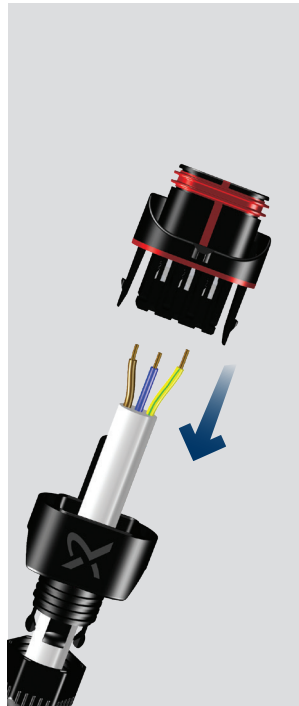
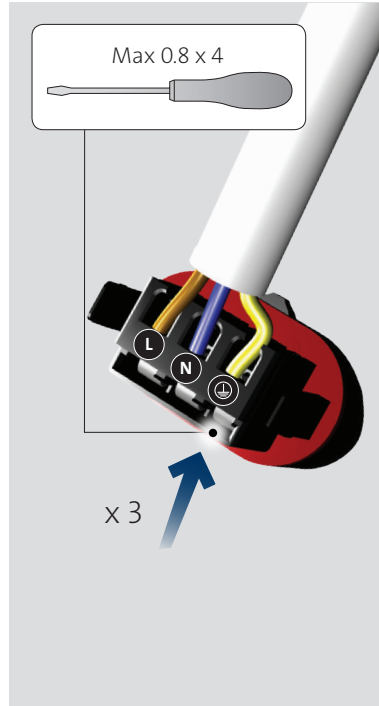
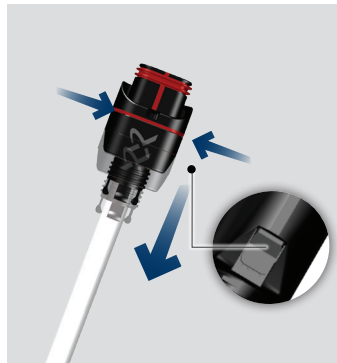
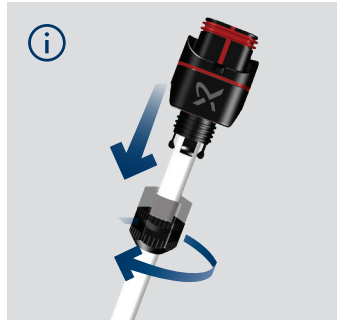
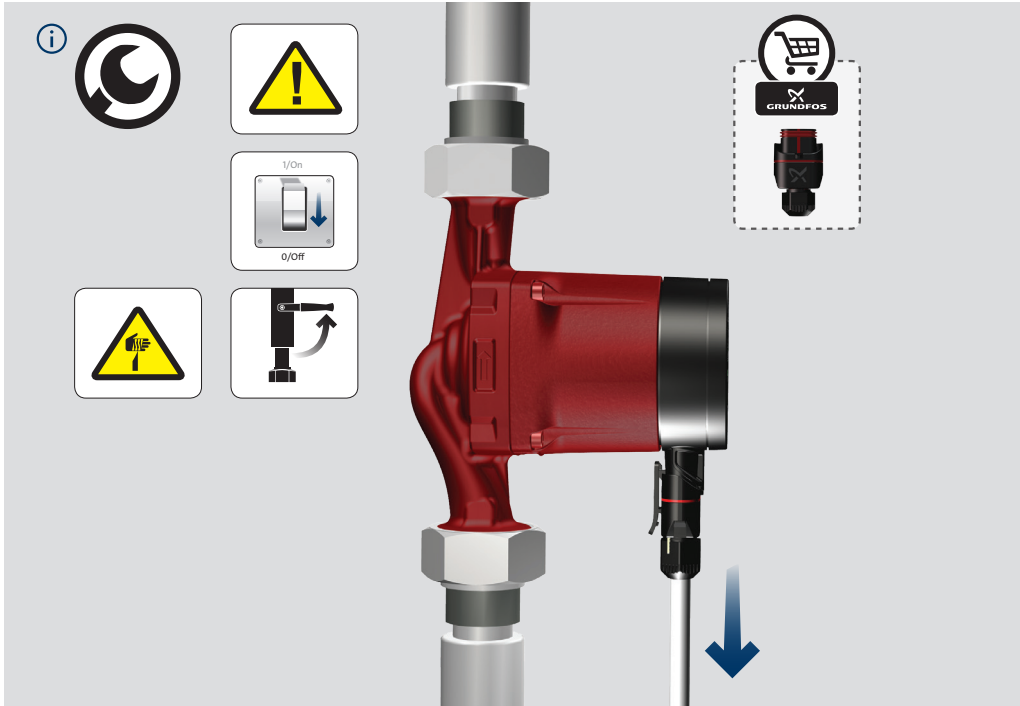
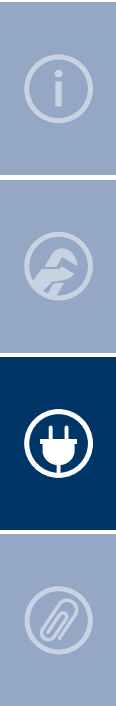



ALPHA1

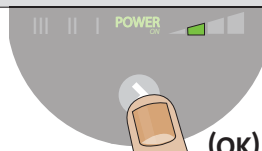
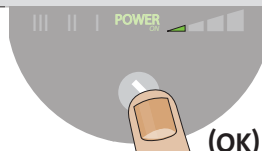
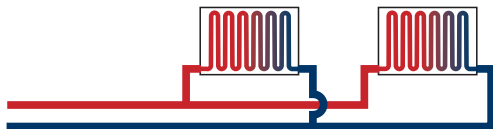
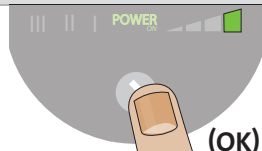
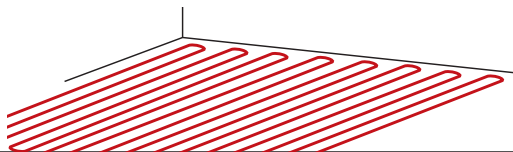

ALPHA1 N

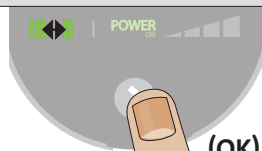
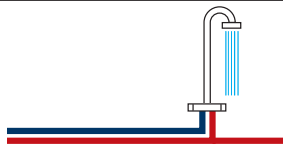

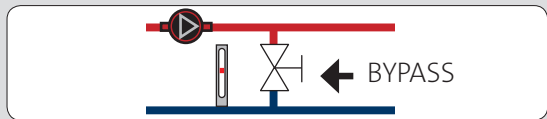

1

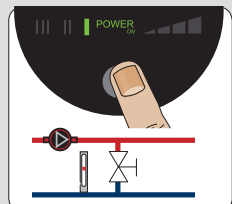

2

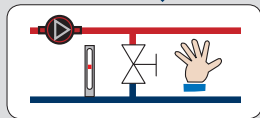

3

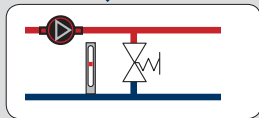

ALPHA1 N

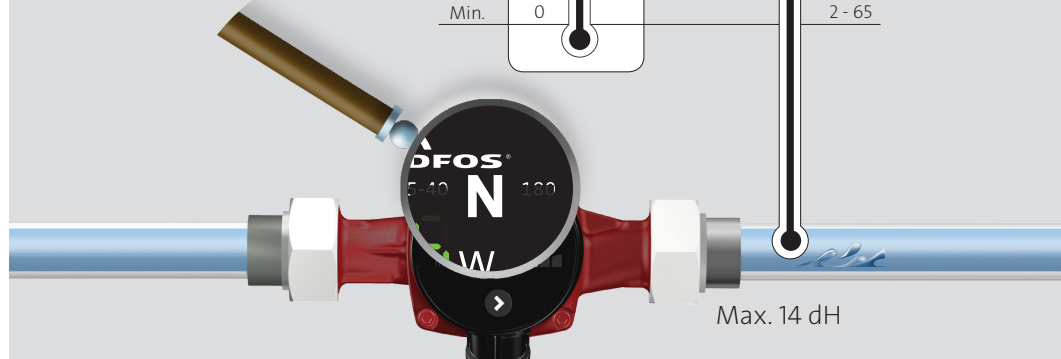
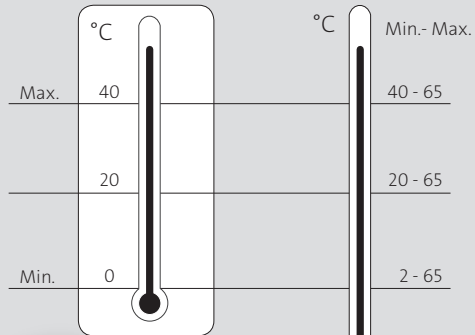



ALPHA1

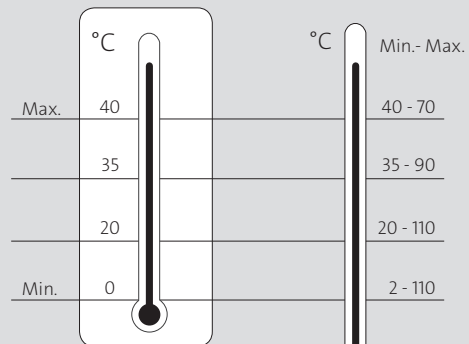

Product No		
25-XX (A)	3/4"	529921
25-XX (A)	1"	529922
32-XX	1"	509921
32-XX	1 1/4"	509922



Product No		
25-XX N	3/4"	529971
25-XX N	1"	529972
32-XX N	1 1/4"	509971



Product No		
25-XX (A)(N)	3/4"	519805
25-XX (A)(N)	1"	519806
32-XX (N)	1 1/4"	505539



Product No		
15-XX	130	505821
25-XX	130	
32-XX	130	



Product No	
15-XX	98284561
25-XX	
32-XX	



Product No		
15-XX A	180	505822
25-XX A	180	



Product No	
15-XX	98610291
25-XX	
32-XX	



DE: Das Symbol mit einer durchgestrichenen Mülltonne weist darauf hin, dass das jeweilige Produkt nicht im Haushaltsmüll entsorgt werden darf. Wenn ein Produkt, das mit diesem Symbol gekennzeichnet ist, das Ende seiner Lebensdauer erreicht hat, bringen Sie es zu einer geeigneten Sammelstelle. Weitere Informationen hierzu erhalten Sie von den zuständigen Behörden vor Ort. Die separate Entsorgung und das

Recycling dieser Produkte trägt dazu bei, die Umwelt und die Gesundheit der Menschen zu schützen.

FR: Le pictogramme représentant une poubelle à roulettes barrée apposé sur le produit signifie que celui-ci ne doit pas être jeté avec les ordures ménagères. Lorsqu'un produit marqué de ce pictogramme atteint sa fin de vie, l'apporter à un point de collecte désigné par les autorités locales compétentes. Le tri sélectif et le recyclage de tels produits participent à la protection de l'environnement et à la préservation de la santé des personnes.

IT: Il simbolo del bidone della spazzatura sbarrato sul prodotto indica che deve essere smaltito separatamente dai rifiuti domestici. Quando un prodotto contrassegnato con questo simbolo raggiunge la fine della vita utile, consegnarlo presso un punto di raccolta designato dagli enti locali per lo smaltimento. La raccolta differenziata ed il riciclo di tali prodotti consentono di tutelare la salute umana e l'ambiente.

DE: EU-Konformitätserklärung

Wir, Grundfos, erklären in alleiniger Verantwortung, dass das Produkt ALPHA1, auf das sich diese Erklärung bezieht, mit den folgenden Richtlinien des Rates zur Angleichung der Rechtsvorschriften der EU-Mitgliedsstaaten übereinstimmt. Die Ökodesign-Richtlinie (2009/125/EG) gilt nicht für die Produktnummern 98463424, 98475986 und 98094952.

FR: Déclaration de conformité UE

Nous, Grundfos, déclarons sous notre seule responsabilité, que le produit ALPHA1, auquel se réfère cette déclaration, est conforme aux Directives du Conseil concernant le rapprochement des législations des États membres UE relatives aux normes énoncées ci-dessous :
La Directive sur l'Eco-conception (2009/125/CE) n'est pas valable pour les codes articles 98463424, 98475986 et 98094952.

IT: Dichiarazione di conformità UE

Grundfos dichiara sotto la sua esclusiva responsabilità che il prodotto ALPHA1, al quale si riferisce questa dichiarazione, è conforme alle seguenti direttive del Consiglio riguardanti il riavvicinamento delle legislazioni degli Stati membri UE:
La direttiva ECODESIGN non di applica ai codici 98463424, 98475986 e 98094952.

Low Voltage Directive (2014/35/EU)

Standards used:

- EN 60335-1:2012/A11:2014/A12:2017/A13:2017
- EN 60335-2-51:2003/A1:2008/A2:2012
- EN62233:2008

EMC Directive (2014/30/EU)

Standards used:

- EN 55014-1:2006/A1:2009/A2:2011
- EN 55014-2:2015
- EN61000-3-2:2014
- EN61000-3-3:2013

Ecodesign Directive (2009/125/EC)

Commission Regulation (EC) No 641/2009
Commission Regulation (EC) No 622/2012
Standards used:

- EN 16297-1:2012
- EN 16297-2:2012

RoHS Directives (2011/65/EU) and (2015/863/EU)

Standard used:

- EN 50581:2012

Bjerringbro, 28-11-2018

Frank Skovgaard
Senior Manager

GRUNDFOS Holding A/S
Poul Due Jensens Vej 7
8850 Bjerringbro, Denmark

Person authorised to compile technical file and empowered to sign the EC declaration of conformity.

**Argentina**

Bombas GRUNDFOS de Argentina S.A.
Ruta Panamericana km. 37.500 Lote 34A
1619 - Garin
Pcia. de Buenos Aires
Phone: +54-3327 414 444

Australia

GRUNDFOS Pumps Pty. Ltd.
P.O. Box 2040
Regency Park
South Australia 5942
Phone: +61-8-8461-4611

Austria

GRUNDFOS Pumpen Vertrieb
Ges.m.b.H.
Grundfosstraße 2
A-5082 Grödig/Salzburg
Tel.: +43-6246-883-0

Belgium

N.V. GRUNDFOS Bellux S.A.
Boomsesteenweg 81-83
B-2630 Aartselaar
Tel.: +32-3-870 7300

Belorussia

Представительство ГРУНДФОС
в Минске
220123, Минск,
ул. В. Хоружей, 22, оф. 1105
Тел.: +(37517) 233 97 65,

Bosnia/Herzegovina

GRUNDFOS Sarajevo
Trg Heroja 16,
BH-71000 Sarajevo
Phone: +387 33 713 290

Brazil

BOMBAS GRUNDFOS DO BRASIL
Av. Humberto de Alencar Castelo
Branco, 630
CEP 09850 - 300
São Bernardo do Campo - SP
Phone: +55-11 4393 5533

Bulgaria

Grundfos Bulgaria EOOD
Slatina District, Iztochna
Tangenta street no. 100
BG - 1592 Sofia
Tel. +359 2 49 22 200

Canada

GRUNDFOS Canada Inc.
2941 Brighton Road
Oakville, Ontario, L6H 6C9
Phone: +1-905 829 9533

China

Grundfos Shanghai 10F, Building No.3
The Hub, No.33 Suhong Road, Minhang
District, Shanghai 201106, China, 201106
Tel.: +86 21-61225222

Croatia

GRUNDFOS CROATIA d.o.o.
Cebini 37, Buzin
HR-10010 Zagreb
Phone: +385 1 6595 400

Czech Republic

GRUNDFOS s.r.o.
Čajkovského 21
779 00 Olomouc
Phone: +420-585-716 111

Denmark

GRUNDFOS DK A/S
Martin Bachs Vej 3
DK-8850 Bjerringbro
Tlf.: +45-87 50 50 50

Estonia

GRUNDFOS Pumps Eesti OÜ
Peterburi tee 92G
11415 Tallinn
Tel: + 372 606 1690

Finland

OY GRUNDFOS Pumput AB
Mestarintie 11
FIN-01730 Vantaa
Phone: + 358 207 889 900

France

Pompes GRUNDFOS Distribution S.A.
Parc d'Activités de Chesnes
57, rue de Malacombe
F-38290 St. Quentin Fallavier (Lyon)
Tél.: +33-4 74 82 15 15

Germany

GRUNDFOS GMBH
Schlüterstr. 33
40699 Erkrath
Tel.: +49-(0) 211 929 69-0

Greece

GRUNDFOS Hellas A.E.B.E.
20th km. Athinon-Markopoulou Av.
PO. Box 71
GR-19002 Peania
Phone: +0030-210-66 83 400

Hong Kong

GRUNDFOS Pumps (Hong Kong) Ltd.
Unit 1, Ground floor
Siu Wai Industrial Centre
29-33 Wing Hong Street &
68 King Lam Street, Cheung Sha Wan
Kowloon
Phone: +852-27861706 / 27861741

Hungary

GRUNDFOS Hungária Kft., Park u. 8
H-2045 Törökbálint,
Phone: +36-23 511 110

India

GRUNDFOS Pumps India
Private Limited
118 Old Mahabalipuram Road
Thoraiakkam Chennai 600 096
Phone: +91-44 2496 6800

Indonesia

PT GRUNDFOS Pompa
Jl. Rawa Sumur III, Blok III / CC-1
Kawasan Industri, Pulogadung
Jakarta 13930
Phone: +62-21-460 6909

Ireland

GRUNDFOS (Ireland) Ltd.
Unit A, Merrywell Business Park
Ballymount Road Lower
Dublin 12
Phone: +353-1-4089 800

Italy

GRUNDFOS Pompe
Italia S.r.l.
Via Gran Sasso 4
I-20060 Truccazzano (Milano)
Tel.: +39-02-95838112

Japan

GRUNDFOS Pumps K.K.
Gotanda Metalion Bldg., 5F,
5-21-15, Higashi-gotanda
Shiagawa-ku, Tokyo 141-0022 Japan
Phone: +81 35 448 1391

Korea

GRUNDFOS Pumps Korea Ltd.
6th Floor, Aju Building 679-5
Yeoksam-dong
Kangnam-ku, 135-916
Seoul, Korea
Phone: +82-2-5317 600

Latvia

SIA GRUNDFOS Pumps Latvia
Deglava biznesa centrs
Augusta Deglava ielā 60,
LV-1035, Rīga,
Tāl.: + 371 714 9640, 7 149 641

Lithuania

GRUNDFOS Pumps UAB
Smolensko g. 6
LT-03201 Vilnius
Tel: + 370 52 395 430

Malaysia

GRUNDFOS Pumps Sdn. Bhd.
7 Jalan Peguam U1/25
Glenmarie Industrial Park
40150 Shah Alam, Selangor
Phone: +60-3-5569 2922

México

Bombas GRUNDFOS de
México S.A. de C.V.
Boulevard TLC No.15
Parque Industrial Stiva Aeropuerto
Apodaca, N.L. 66600
Phone: +52-81-8144 4000

Netherlands

GRUNDFOS Netherlands
Veluwezoom 35
1326 AE Almere
Postbus 22015
1302 CA ALMERE
Tel.: +31-88-478 6336

New Zealand

GRUNDFOS Pumps NZ Ltd.
17 Beatrice Tinsley Crescent
North Harbour Industrial Estate
Albany, Auckland
Phone: +64-9-415 3240

Norway

GRUNDFOS Pumper A/S
Strømsveien 344
Postboks 235, Leirdal
N-1011 Oslo
Tlf.: +47-22 90 47 00

Poland

GRUNDFOS Pompy Sp. z o.o.
ul. Klonowa 23
Baranowo k. Poznania
PL-62-081 Przeźmierowo
Tel: (+48-61) 650 13 00

Portugal

Bombas GRUNDFOS Portugal, S.A.
Rua Calvet de Magalhães, 241
Apartado 1079
P-2770-153 Paço de Arcos
Tel.: +351-21-440 76 00

România

GRUNDFOS Pompe România SRL
Bd. Biruintei, nr 103
Pantelimon county Ilfov
Phone: +40 21 200 4100

Russia

ООО Грундфос
Россия, 109544 Москва,
ул. Школьная 39
Тел. (+7) 495 737 30 00, 564 88 00

Serbia

GRUNDFOS Predstavništvo Beograd, Dr.
Milutina Ivkovića 2a/29, YU-11000 Beograd
Phone: +381 11 26 47 877 /
11 26 47 496

Singapore

GRUNDFOS (Singapore) Pte. Ltd.
24 Tuas West Road
Jurong Town
Singapore 638381
Phone: +65-6865 1222

Slovenia

GRUNDFOS d.o.o.
Šlandrova 8b, SI-1231 Ljubljana-Črnuče
Phone: +386 1 568 0610

South Africa

GRUNDFOS (PTY) LTD
Corner Mountjoy and George Allen Roads
Wilbart Ext. 2
Bedfordview 2008
Phone: (+27) 11 579 4800

Spain

Bombas GRUNDFOS España S.A.
Camino de la Fuentecilla, s/n
E-28110 Algete (Madrid)
Tel.: +34-91-848 8800

Sweden

GRUNDFOS AB
Box 333 (Lunnagårdsgatan 6)
431 24 Mölndal
Tel.: +46 31 332 23 000

Switzerland

GRUNDFOS Pumpen AG
Bruggacherstrasse 10
CH-8117 Fällanden/ZH
Tel.: +41-1-806 8111

Taiwan

GRUNDFOS Pumps (Taiwan) Ltd.
7 Floor, 219 Min-Chuan Road
Taichung, Taiwan, R.O.C.
Phone: +886-4-2305 0868

Thailand

GRUNDFOS (Thailand) Ltd.
92 Chaloein Phrakiat Rama 9 Road,
Dokmai, Pravej, Bangkok 10250
Phone: +66-2-725 8999

Turkey

GRUNDFOS POMPA San.ve Tic. Ltd. Sti.
Gebze Organize Sanayi Bölgesi
Ihsan dede Caddesi,
2. yol 200. Sokak No. 204
41490 Gebze / Kocaeli
Phone: +90 - 262-679 7979

Ukraine

ТОВ ГРУНДФОС УКРАЇНА
01010 Київ, Буль. Московська 86,
Тел.:(+38 044) 390 40 50

United Arab Emirates

GRUNDFOS Gulf Distribution
P.O. Box 16768
Jebel Ali Free Zone
Dubai
Phone: +971 4 8815 166

United Kingdom

GRUNDFOS Pumps Ltd.
Grovebury Road
Leighton Buzzard/Beds. LU7 8TL
Phone: +44-1525-850000

U.S.A.

GRUNDFOS Pumps Corporation
17100 West 118th Terrace
Olathe, Kansas 66061
Phone: +1-913-227-3400

Uzbekistan

Представительство ГРУНДФОС в Ташкенте
700000 Ташкент ул.Усмана Носира 1-й
тулик 5
Телефон: (3712) 55-68-15

Kazakhstan

Республика Казахстан
Грундфос Казахстан ЖШС
Қазақстан Республикасы,
КЗ-050010 Алматы қ., Көк-Төбе
шағын ауданы, Қыз-Жібек көшесі, 7,
Тел: (+7) 727 227-98-54
Факс: (+7) 727 239-65-70



Installation date: _____

Installer:



98967867 0319 / ECM: 1254753



(93)98967867

GRUNDFOS Holding A/S

Poul Due Jensens Vej 7
DK-8850 Bjerringbro
Tel: +45 87 50 14 00

www.grundfos.com

GRUNDFOS 