

MIN MAX

ADI ASSOCIAZIONE
PER IL DISEGNO
INDUSTRIALE
DESIGN AWARD
2017@CERSAIE

JOLLY/JOLLY FREE



MINIMUM PROFILE,
MAXIMUM ADJUSTABILITY
AND UNIQUE DESIGN

PROVEX
comfort in the bathroom

INDICE JOLLY/JOLLY FREE
 INHALT JOLLY/JOLLY FREE
 INDEX JOLLY/JOLLY FREE
 INDICE JOLLY/JOLLY FREE

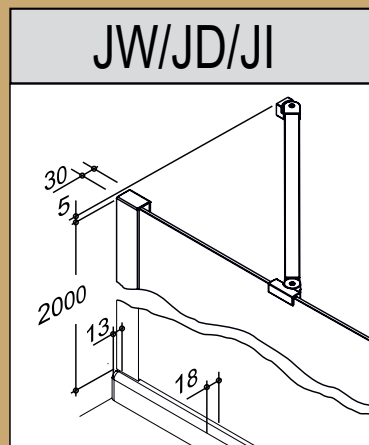
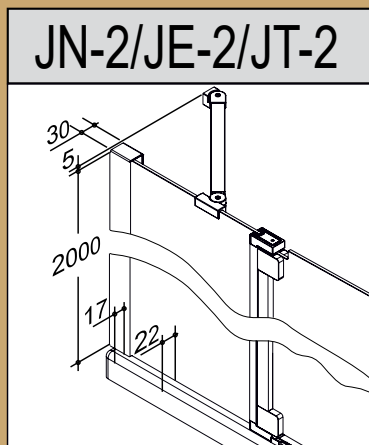
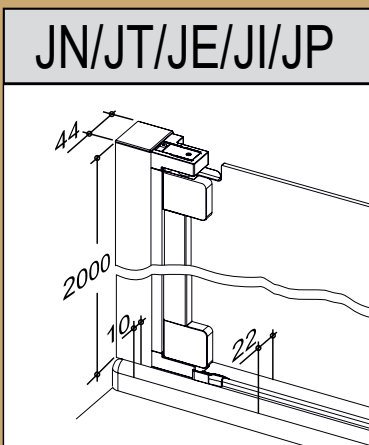
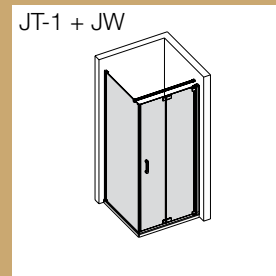
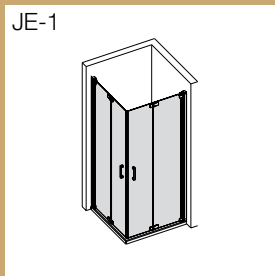
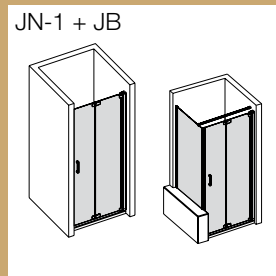
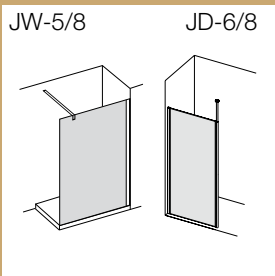
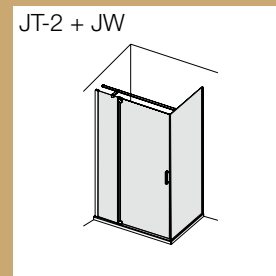
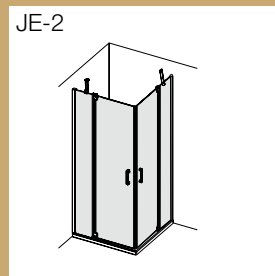
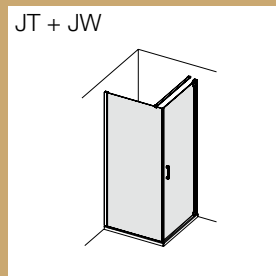
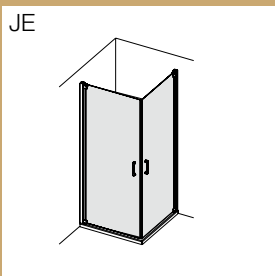
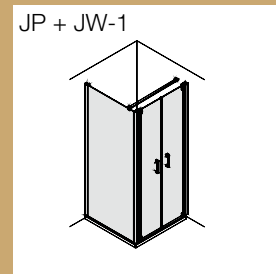
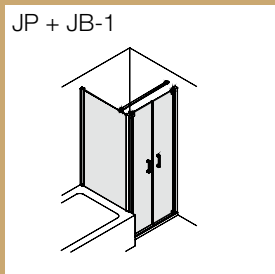
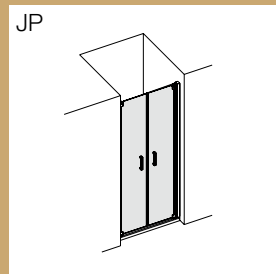
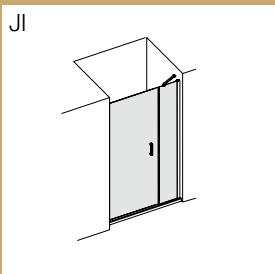
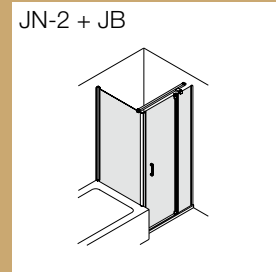
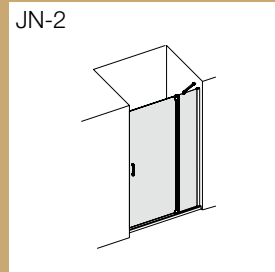
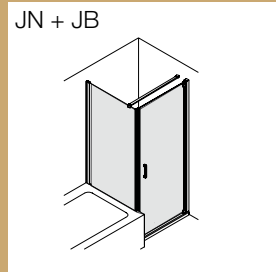
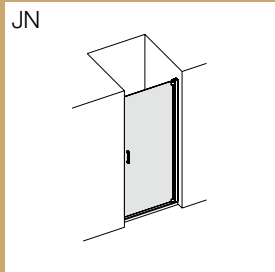

ADI ADI ASSOCIAZIONE
PER IL DISEGNO
INDUSTRIALE
**DESIGN AWARD
2017@CERSAIE**

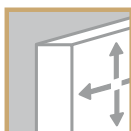

BOX CON PARZIALE TELAIO

- **MinMax** – il sistema innovativo con un'estensibilità fino a 90 mm
- Design eccezionale senza profili orizzontali
- Cerniera basculante IN/OUT fino a 270°
- Porte con meccanismo di sollevamento/abbassamento invisibile e attivo
- Altezza vetro e profilo uniforme di 2000 mm
- Regolazione di precisione e aggiustamento postumo di tutti gli elementi
- Tenuta stagna testata a 11 litri/minuto
- Profilo a parete senza bisogno di silicone

TEILRAHMENKABINEN

- **MinMax** – das innovative System mit bis zu 90 mm Verstellbereich
- Herausragendes Design ohne Querverbinder
- Pendelscharnier IN/OUT bis zu 270°
- Türelemente mit unsichtbarem und aktivem Hebe- Senkmechanismus
- Einheitliche Glas- und Profilhöhe 2000 mm
- Stufenlose Feineinstellung und Nachadjustierung aller Elemente
- Getestete Wasserdichtigkeit von 11 Liter/Minute
- Silikonfreier Wandanschluss

PARTIAL FRAMED SHOWER ENCLOSURE

- **MinMax** – the innovative system with adjustment up to 90 mm
- Outstanding design without horizontal profiles
- Saloon door hinges IN/OUT up to 270°
- Door elements with active and invisible up and down lifting mechanism
- Uniform glass and profile height 2000 mm
- Infinitely micro- and re-adjustment of all elements
- Tested to be watertight 11 liters per minute
- Silicon free wall junction

CABINA CON PERFIL PARCIAL

- **MinMax** – un sistema innovador con una extensibilidad de 90 mm
- Diseño excepcional sin perfil horizontal
- Bisagra basculante IN/OUT hasta 270°
- Puertas con mecanismo de levantamiento/descenso invisible y activo
- Altura vidrio y perfil uniforme 2000 mm
- Regulación extrema en el ajustamento de todos los elementos
- Probado que es estanca para un caudal 11 litros/minutos
- Fijación a pared sin necesidad de silicona

JOLLY JN + JB

PORTA BASCULANTE + LATERALE PER VASCA
PENDELTÜR + SEITENWAND FÜR BADEWANNE
SALOON DOOR + SIDE PANEL FOR BATHTUB
PUERTA BASCULANTE + PARED PARA BAÑERA



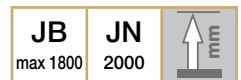

Descrizione Articolo Artikelbezeichnung Model description Descripción artículo	Articolo Artikel Model Código	Misura piatto doccia Tassenmaß Tray size Medidas del plato mm	Estensibilità Verstellbarkeit Adjustability Extensibilidad mm MINMAX	Misura Maß Size Medidas mm A B
<p>Porta basculante* Pendeltür 1-teilig* Saloon door* Puerta basculante*</p> <p>IN OUT</p>	0070 JN	700	668 - 723	585 615
	0075 JN	750	718 - 773	635 665
	0080 JN	800	768 - 823	685 715
	0090 JN	900	868 - 923	785 815
	0100 JN	1000	968 - 1023	885 915

* Il vetro GH del modello JN non è reversibile, si prega di indicare il lato di montaggio / Die Glasart GH ist beim Modell JN nicht reversibel, bitte Montageseite angeben
The glass GH is not reversible in model JN, please specify the mounting side / El vidrio GH es el modelo JN no es reversible, por favor indique lado de montaje

<p>Laterale per vasca Seitenteil für Badewanne Side panel for bathtub Pared lateral para bañera</p>	0015 JB*	700 - 1000	25			

* Articolo é sempre un fuori misura / Artikel ist immer Sondermaß / article is always special measure / artículo es siempre medida especial

Indicare sempre bordo piatto fino bordo vasca/muretto
Oberkante Duschtasse bis Badewanne/Mauer immer angeben
Indicate always shower tray to bathtub panel/wall
Indique siempre borde superior plato de ducha y bañera/muro



JN - L

JN - R

JOLLY JN-2 + JB

PORTA BASCULANTE IN LINEA + LATERALE PER VASCA

PENDELTÜR MIT FESTFELD IN LINIE + SEITENWAND FÜR BADEWANNE

SALOON DOOR WITH IN-LINE FIXED PANEL + SIDE PANEL FOR BATHTUB

PUERTA BASCULANTE CON LATERAL FIJO + PARED PARA BAÑERA



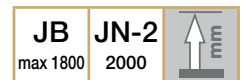

Descrizione Articolo Artikelbezeichnung Model description Descripción artículo	Articolo Artikel Model Código	Misura piatto doccia Tassenmaß Tray size Medidas del plato mm	Estensibilità Verstellbarkeit Adjustability Extensibilidad mm MINMAX	Misura Maß Size Medidas mm A B
<p>Porta basculante in linea* Pendeltür mit Festfeld in Linie* Saloon door with in-line fixed panel* Puerta basculante con lateral fijo*</p>	2090 JN	900	868 - 943	570 310
	2100 JN	1000	968 - 1043	670 310
	2110 JN	1100	1068 - 1143	670 410
	2120 JN	1200	1168 - 1243	670 510
	2140 JN	1400	1368 - 1443	670 710
	2160 JN	1600	1568 - 1643	670 910

* Il vetro GH del modello JN non è reversibile, si prega di indicare il lato di montaggio / Die Glasart GH ist beim Modell JN nicht reversibel, bitte Montageseite angeben
The glass GH is not reversible in model JN, please specify the mounting side / El vidrio GH es el modelo JN no es reversible, por favor indique lado de montaje

Articolo Artikel Model Código	Misura piatto doccia Tassenmaß Tray size Medidas del plato mm	Estensibilità Verstellbarkeit Adjustability Extensibilidad mm	Misura Maß Size Medidas mm
0015 JB*	700 - 1000	25	

* Articolo è sempre un fuori misura / Artikel ist immer Sondermaß / article is always special measure / artículo es siempre medida especial

Indicare sempre bordo piatto fino bordo vasca/muretto
Oberkante Duschtasse bis Badewanne/Mauer immer angeben
Indicate always shower tray to bathtub panel/wall
Indique siempre borde superior plato de ducha y bañera/muro



JOLLY JI

PORTA BASCULANTE IN LINEA

PENDELTÜR MIT FESTFELD IN LINIE

SALOON DOOR WITH IN-LINE FIXED PANEL

PUERTA BASCULANTE CON LATERAL FIJO





Descrizione Articolo Artikelbezeichnung Model description Descripción artículo	Articolo Artikel Model Código	Misura piatto doccia Tassenmaß Tray size Medidas del plato mm	Estensibilità Verstellbarkeit Adjustability Extensibilidad mm MINMAX	Misura Maß Size Medidas mm A B C
<p>Porta basculante in linea* Pendeltür mit Festfeld in Linie* Saloon door with in-line fixed panel* Puerta basculante con lateral fijo*</p>	0100 JI	1000	952 - 1042	327 583 613
	0110 JI	1100	1052 - 1142	327 683 713
	0120 JI	1200	1152 - 1242	327 783 813
	0140 JI	1400	1352 - 1442	527 783 813
	0160 JI	1600	1552 - 1642	727 783 813

* Il vetro GH del modello JI non è reversibile, si prega di indicare il lato di montaggio / Die Glasart GH ist beim Modell JI nicht reversibel, bitte Montageseite angeben
The glass GH is not reversible in model JI, please specify the mounting side / El vidrio GH es el modelo JI no es reversible, por favor indique lado de montaje



JOLLY JP + JB-1

PORTA BASCULANTE + LATERALE PER VASCA
PENDELTÜR + SEITENWAND FÜR BADEWANNE
SALOON DOOR + SIDE PANEL FOR BATHTUB
PUERTA BASCULANTE + PARED PARA BAÑERA



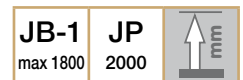

Descrizione Articolo Artikelbezeichnung Model description Descripción artículo	Articolo Artikel Model Código	Misura piatto doccia Tassenmaß Tray size Medidas del plato mm	Estensibilità Verstellbarkeit Adjustability Extensibilidad mm MINMAX	Misura Maß Size Medidas mm A
<p>Porta basculante Pendeltür 2-teilig Saloon door Puerta basculante</p>	0070 JP	700	655 - 745	525
	0075 JP	750	705 - 795	575
	0080 JP	800	755 - 845	625
	0090 JP	900	855 - 945	725
	0100 JP	1000	955 - 1045	825
	0120 JP	1200	1155 - 1245	1025

<p>Laterale per vasca Seitenteil für Badewanne Side panel for bathtub Pared lateral para bañera</p>	1015 JB*	700 - 1000	25				

* Articolo é sempre un fuori misura / Artikel ist immer Sondermaß / article is always special measure / artículo es siempre medida especial

Indicare sempre bordo piatto fino bordo vasca/muretto
Oberkante Duschtasse bis Badewanne/Mauer immer angeben
Indicate always shower tray to bathtub panel/wall
Indique siempre borde superior plato de ducha y bañera/muro

JOLLY JP + JW-1

PORTA BASCULANTE + LATERALE
PENDELTÜR + SEITENWAND
SALOON DOOR + SIDE PANEL
PUERTA BASCULANTE + PARED



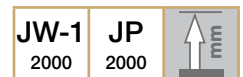

Descrizione Articolo Artikelbezeichnung Model description Descripción artículo		Articolo Artikel Model Código	Misura piatto doccia Tassenmaß Tray size Medidas del plato mm	Estensibilità Verstellbarkeit Adjustability Extensibilidad mm MINMAX	Misura centro vetro Mitte Glasmaß Glass size middle Medida vidrio centro mm	Misura Maß Size Medidas mm A	
<p>Porta basculante Pendeltür 2-teilig Saloon door Puerta basculante</p>		0070 JP	700	675 - 765	660 - 750	525	
		0075 JP	750	725 - 815	710 - 800	575	
		0080 JP	800	775 - 865	760 - 850	625	
		0090 JP	900	875 - 965	860 - 950	725	
		0100 JP	1000	975 - 1065	960 - 1050	825	
		0120 JP	1200	1175 - 1265	1160 - 1250	1025	
<p>Laterale per porta basculante Seitenwand für Pendeltür Side panel for saloon door Lateral para puerta basculante</p>		1070 JW	700	675 - 720	660 - 705		
		1075 JW	750	725 - 770	710 - 755		
		1080 JW	800	775 - 820	760 - 805		
		1082 JW		800 - 845	785 - 830		
		1090 JW	900	875 - 920	860 - 905		
		1092 JW		900 - 945	885 - 930		
		1100 JW	1000	975 - 1020	960 - 1005		
	1102 JW		1000 - 1045	985 - 1030			

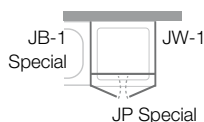
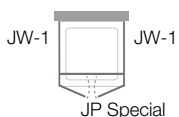

JOLLY JE

BOX AD ANGOLO
ECKEINSTIEG
CORNER ENTRY
CABINA ANGULAR





Descrizione Articolo Artikelbezeichnung Model description Descripción artículo	Articolo Artikel Model Código	Misura piatto doccia Tassenmaß Tray size Medidas del plato mm	Estensibilità Verstellbarkeit Adjustability Extensibilidad mm MINMAX	Misura centro vetro Mitte Glasmaß Glass size middle Medida vidrio centro mm	Misura Maß Size Medidas mm A
<p>Box ad angolo* Eckeinstieg* Corner entry* Cabina angular*</p>	0070 JE**	700	665 - 710	650 - 695	810
	0075 JE**	750	715 - 760	700 - 745	880
	0080 JE**	800	765 - 810	750 - 795	950
	0082 JE**		800 - 845	785 - 830	1000
	0090 JE**	900	865 - 910	850 - 895	1090
	0092 JE**		900 - 945	885 - 930	1140
	0100 JE**	1000	965 - 1010	950 - 995	1230
	0102 JE**		1000 - 1045	985 - 1030	1280

* Il vetro GH del modello JE non è reversibile, si prega di indicare il lato di montaggio / Die Glasart GH ist beim Modell JE nicht reversibel, bitte Montageseite angeben
The glass GH is not reversible in model JE, please specify the mounting side / El vidrio GH es el modelo JE no es reversible, por favor indique lado de montaje

** Usate 2 articoli JE per il box completo / Verwenden Sie 2 x Artikel JE für die komplette Kabine / Use 2 article JE for the complete box / Le rogamos de usar 2 x JE para la cabina completa

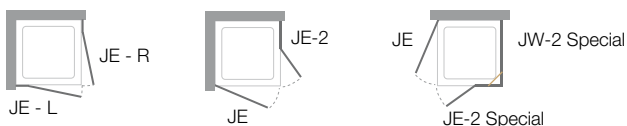

JOLLY JT + JW

PORTA BASCULANTE + LATERALE

PENDELTÜR + SEITENWAND

SALOON DOOR + SIDE PANEL

PUERTA BASCULANTE + PARED





Descrizione Articolo Artikelbezeichnung Model description Descripción artículo	Articolo Artikel Model Código	Misura piatto doccia Tassenmaß Tray size Medidas del plato mm	Estensibilità Verstellbarkeit Adjustability Extensibilidad mm MIN MAX	Misura centro vetro Mitte Glasmaß Glass size middle Medida vidrio centro mm	Misura Maß Size Medidas mm A B		
 Porta basculante con sostegno* Pendeltür mit Stütze* Saloon door with support* Puerta basculante con soporte* 	0070 JT	700	665 - 710	650 - 695	585 615		
	0075 JT	750	715 - 760	700 - 745	635 665		
	0080 JT	800	765 - 810	750 - 795	685 715		
	0082 JT			800 - 845	785 - 830	720 750	
	0090 JT	900	865 - 910	850 - 895	785 815		
	0092 JT			900 - 945	885 - 930	820 850	
	0100 JT	1000	965 - 1010	950 - 995	885 915		
	0102 JT			1000 - 1045	985 - 1030	920 950	

* Il vetro GH del modello JT non è reversibile, si prega di indicare il lato di montaggio / Die Glasart GH ist beim Modell JT nicht reversibel, bitte Montageseite angeben
 The glass GH is not reversible in model JT, please specify the mounting side / El vidrio GH es el modelo JT no es reversible, por favor indique lado de montaje

 Laterale per porta basculante Seitenteil für Pendeltür Side panel for saloon door Pared lateral para puerta basculante	0070 JW	700	665 - 710	650 - 695			
	0075 JW	750	715 - 760	700 - 745			
	0080 JW	800	765 - 810	750 - 795			
	0082 JW			800 - 845	785 - 830		
	0090 JW	900	865 - 910	850 - 895			
	0092 JW			900 - 945	885 - 930		
	0100 JW	1000	965 - 1010	950 - 995			
	0102 JW			1000 - 1045	985 - 1030		
	0120 JW	1200	1165 - 1210	1150 - 1195			



JW

JW-1

JW

JT-L

JT-R

JT-L Special

JOLLY JE-2

BOX AD ANGOLO
ECKEINSTIEG
CORNER ENTRY
CABINA ANGULAR



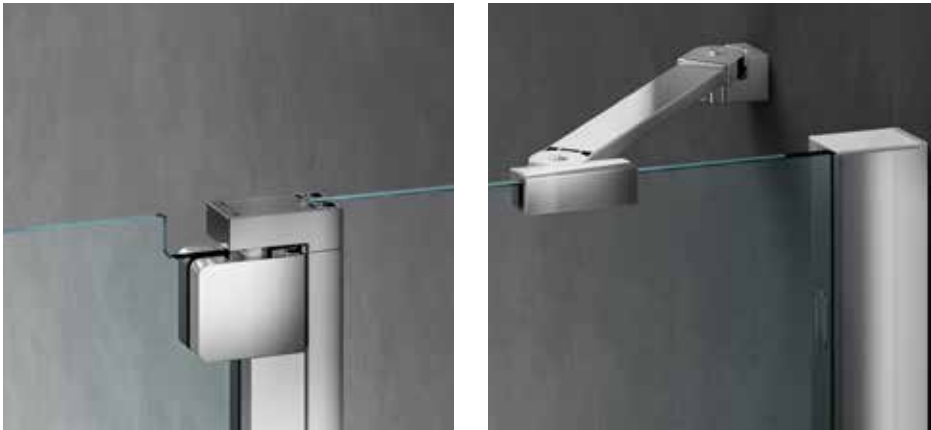

Descrizione Articolo Artikelbezeichnung Model description Descripción artículo	Articolo Artikel Model Código	Misura piatto doccia Tassenmaß Tray size Medidas del plato mm	Estensibilità Verstellbarkeit Adjustability Extensibilidad mm MINMAX	Misura centro vetro Mitte Glasmaß Glass size middle Medida vidrio centro mm	Misura Maß Size Medidas mm		
					A	B	C
 <p>Box ad angolo* Eckkabine* Corner entry* Cabina angular*</p>	2070 JE **	700	665 - 730	650 - 715	510	370	310
	2075 JE **	750	715 - 780	700 - 765	580	420	310
	2080 JE **	800	765 - 830	750 - 815	650	470	310
	2090 JE **	900	865 - 930	850 - 915	795	570	310
	2100 JE **	1000	965 - 1030	950 - 1015	935	670	310
	2110 JE **	1100	1065 - 1130	1050 - 1115	935	670	410
	2120 JE **	1200	1165 - 1230	1150 - 1215	935	670	510

* Il vetro GH del modello JE non è reversibile, si prega di indicare il lato di montaggio / Die Glasart GH ist beim Modell JE nicht reversibel, bitte Montageseite angeben
The glass GH is not reversible in model JE, please specify the mounting side / El vidrio GH es el modelo JE no es reversible, por favor indique lado de montaje

** Usate 2 articoli JE per il box completo / Verwenden Sie 2 x Artikel JE für die komplette Kabine / Use 2 article JE for the complete box / Le rogamos de usar 2 x JE para la cabina completa

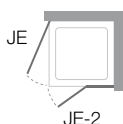
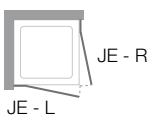

JOLLY JT-2 + JW

PORTA BASCULANTE IN LINEA + LATERALE

PENDELTÜR MIT FESTFELD IN LINIE + SEITENWAND

SALOON DOOR WITH IN-LINE FIXED PANEL + SIDE PANEL

PUERTA BASCULANTE CON LATERAL FIJO + PARED LATERAL





Descrizione Articolo Artikelbezeichnung Model description Descripción artículo	Articolo Artikel Model Código	Misura piatto doccia Tassenmaß Tray size Medidas del plato mm	Estensibilità Verstellbarkeit Adjustability Extensibilidad mm MINMAX	Misura centro vetro Mitte Glasmaß Glass size middle Medida vidrio centro mm	Misura Maß Size Medidas mm		
					A	B	C
 Porta basculante in linea* Pendeltür in Linie* Saloon door inline* Puerta basculante en línea*	2090 JT	900	865 - 930	850 - 915	570	310	
	2100 JT	1000	965 - 1030	950 - 1015	670	310	
	2110 JT	1100	1065 - 1130	1050 - 1115	670	410	
	2120 JT	1200	1165 - 1230	1150 - 1215	670	510	
	2140 JT	1400	1365 - 1430	1350 - 1415	670	710	
	2160 JT	1600	1565 - 1630	1550 - 1615	670	910	

* Il vetro GH del modello JT non è reversibile, si prega di indicare il lato di montaggio / Die Glasart GH ist beim Modell JT nicht reversibel, bitte Montageseite angeben
 The glass GH is not reversible in model JT, please specify the mounting side / El vidrio GH es el modelo JT no es reversible, por favor indique lado de montaje

 Laterale* Seitenteil* Side panel* Pared lateral*	0070 JW	700	665 - 710	650 - 695				
	0075 JW	750	715 - 760	700 - 745				
	0080 JW	800	765 - 810	750 - 795				
	0082 JW			800 - 845	785 - 830			
	0090 JW	900		865 - 910	850 - 895			
	0092 JW			900 - 945	885 - 930			
	0100 JW	1000		965 - 1010	950 - 995			
	0102 JW			1000 - 1045	985 - 1030			
	0120 JW	1200		1165 - 1210	1150 - 1195			



JW



JT-2 R

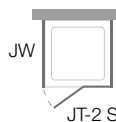

JW

JT-2 Special

JT-2 Special

JOLLY JW-5/8

PARETE DOCCIA CON SOSTEGNO
RAUMABTRENNUNG MIT STÜTZE
SHOWER SCREEN WITH SUPPORT
SEPARA EL ESPACIO CON APOYO

 **EASY-FIX**



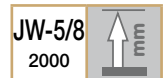

Descrizione Articolo Artikelbezeichnung Model description Descripción artículo	Articolo Artikel Model Código	Misura Maß Size Medidas mm A	Estensibilità Verstellbarkeit Adjustability Extensibilidad mm A	Estensibilità Verstellbarkeit Adjustability Extensibilidad mm B	Misura Maß Size Medidas mm A B
 <p>Parete doccia con sostegno Raumabtrennung mit Stütze Shower screen with support Separa el espacio con apoyo</p>	5100 JW	1000	980 - 1005	450 - 1200*	6 mm
	5110 JW	1100	1080 - 1105	450 - 1200*	
	5120 JW	1200	1180 - 1205	450 - 1200*	
	5130 JW	1300	1280 - 1305	450 - 1200*	
	5140 JW	1400	1380 - 1405	450 - 1200*	
 <p>Parete doccia con sostegno Raumabtrennung mit Stütze Shower screen with support Separa el espacio con apoyo</p>	8100 JW	1000	985 - 1010	450 - 1200*	8 mm
	8110 JW	1100	1085 - 1110	450 - 1200*	
	8120 JW	1200	1185 - 1210	450 - 1200*	
	8130 JW	1300	1285 - 1310	450 - 1200*	
	8140 JW	1400	1385 - 1410	450 - 1200*	

* Sostegno può essere montato anche a 45°/Stütze kann auch diagonal montiert werden/support can be installed diagonal/ Apoyo también puede ser montado en diagonal



JW

JW

JOLLY JD-6/8

PARETE DOCCIA CON SOSTEGNO
RAUMABTRENNUNG MIT STÜTZE
SHOWER SCREEN WITH SUPPORT
SEPARA EL ESPACIO CON APOYO

 **EASY-FIX**

**ALL
SPECIAL**





High
GLASS



JD-6/8
2000



GH
High
Glass

GL

8/6 mm

05

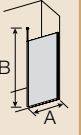
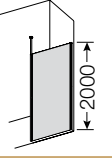
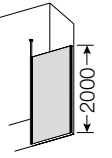

Descrizione Articolo Artikelbezeichnung Model description Descripción artículo	Articolo Artikel Model Código	Misura Maß Size Medidas mm A	Estensibilità Verstellbarkeit Adjustability Extensibilidad mm	Misura Maß Size Medidas mm B	Misura Maß Size Medidas mm 
 <p>Parete doccia con sostegno a soffitto Raumabtrennung mit Deckenstütze Shower screen with ceiling support Separa el espacio con apoyo puntales</p>	6015 JD*	600 - 1010	15	max. 2790	6 mm
	6057 JD*	1011 - 1210	15	max. 2790	
	6079 JD*	1211 - 1410	15	max. 2790	
 <p>Parete doccia con sostegno a soffitto Raumabtrennung mit Deckenstütze Shower screen with ceiling support Separa el espacio con apoyo puntales</p>	8015 JD*	600 - 1010	15	max. 2790	8 mm
	8057 JD*	1011 - 1210	15	max. 2790	
	8079 JD*	1211 - 1410	15	max. 2790	
	8911 JD*	1411 - 1610	15	max. 2790	

* Articolo sempre fuori misura / Artikel ist immer Sondermaß / Article is always special measure / Artículo es siempre medida especial



JOLLY FREE JN-1 + JB

PORTA SOFFIETTO
PENDEL-FALTTÜR
BI-FOLD DOOR
PUERTA PLEGABLE





High
GLASS



JN-1 **JB**
2000 max. 1800



GH* **GL** **6 mm**
High Glass

05

Descrizione Articolo Artikelbezeichnung Model description Descripción artículo	Articolo Artikel Model Código	Misura piatto doccia Tassenmaß Tray size Medidas del plato mm	Estensibilità Verstellbarkeit Adjustability Extensibilidad mm		Estensibilità laterale Verstellbarkeit Seitenteil Adjustability side panel Extensibilidad lateral mm	Misura Maß Size Medidas mm		
			MIN	MAX		A	B	C
 Porta soffietto* Pendel-Faltrittür* Bi-fold door* Puerta plegable*	1070 JN	700	668 - 723		585	80	300	
	1075 JN	750	718 - 773		635	80	325	
	1080 JN	800	768 - 823		685	80	350	
	1090 JN	900	868 - 923		785	80	400	
	1100 JN	1000	968 - 1023		885	80	450	
	1120 JN	1200	1168 - 1223		1085	80	550	

* Il vetro GH non è reversibile, si prega di indicare il lato di montaggio / Die Glasart GH ist nicht reversibel, bitte Montageseite angeben
 The glass GH is not reversible, please specify the mounting side / El vidrio GH no es reversible, por favor indique lado de montaje

 Laterale per vasca Seitenteil für Badewanne Side panel for bathtub Pared lateral para bañera	Articolo	Misura	Estensibilità	Estensibilità laterale	Misura		
	Model	mm	mm	mm	A	B	C
	0015 JB**	700 - 1000		25			

** Articolo é sempre un fuori misura / Artikel ist immer Sondermaß / article is always special measure / artículo es siempre medida especial

Indicare sempre bordo piatto fino bordo vasca/muretto
 Oberkante Duschtasse bis Badewanne/Mauer immer angeben
 Indicate always shower tray to bathtub panel/wall
 Indique siempre borde superior plato de ducha y bañera/muro



JOLLY FREE JE-1

BOX AD ANGOLO PIEGHEVOLE
ECKEINSTIEG KLAPPBAR
FOLDING CORNER ENTRY
CABINA ANGULAR PLEGABLE





High
GLASS



JE-1
2000

GH*
High
Glass

GL

6 mm

05

Descrizione Articolo Artikelbezeichnung Model description Descripción artículo	Articolo Artikel Model Código	Misura piatto doccia Tassenmaß Tray size Medidas del plato mm	Estensibilità Verstellbarkeit Adjustability Extensibilidad mm MINMAX	Misura centro vetro Mitte Glasmaß Glass size middle Medida vidrio centro mm	Misura Maß Size Medidas mm		
					A	B	C
 <p>Box ad angolo pieghevole** EckEinstieg klappbar** Folding corner entry** Cabina angular plegable**</p> 	1070 JE	700	665 - 710	650 - 695	810	80	300
	1075 JE	750	715 - 760	700 - 745	880	80	325
	1080 JE	800	765 - 810	750 - 795	950	80	350
	1082 JE		800 - 845	785 - 830	1000	80	385
	1090 JE	900	865 - 910	850 - 895	1090	80	400
	1092 JE		900 - 945	885 - 930	1140	80	435
	1100 JE	1000	965 - 1010	950 - 995	1230	80	450
	1102 JE		1000 - 1045	985 - 1030	1280	80	485
	1120 JE	1200	1165 - 1210	1150 - 1195	1370	80	550

* Il vetro GH non è reversibile, si prega di indicare il lato di montaggio / Die Glasart GH ist nicht reversibel, bitte Montageseite angeben
The glass GH is not reversible, please specify the mounting side / El vidrio GH no es reversible, por favor indique lado de montaje

** Usate 2 articoli per il box completo/Verwenden Sie 2 x Artikel für die komplette Kabine/Use 2 articles for the complete enclosure/Le rogamos de usar 2 x artículos para la cabina completa

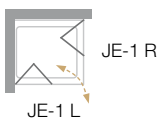

JOLLY FREE JT-1 + JW

PORTA SOFFIETTO CON LATERALE

PENDEL-FALTTÜR MIT SEITENTEIL

BI-FOLD DOOR WITH SIDE PANEL

PUERTA PLEGABLE CON PARED LATERAL





High
GLASS



JT-1
2000

JW
2000

GH*
High
Glass

GL

6 mm

05

Descrizione Articolo Artikelbezeichnung Model description Descripción artículo	Articolo Artikel Model Código	Misura piatto doccia Tassenmaß Tray size Medidas del plato mm	Estensibilità Verstellbarkeit Adjustability Extensibilidad mm	Misura centro vetro Mitte Glasmaß Glass size middle Medida vidrio centro mm	Misura Maß Size Medidas mm		
					A	B	C
<p>Porta soffietto * Pendel-Falttür * Bi-fold door * Puerta plegable *</p>	1070 JT	700	665 - 710	650 - 695	585	80	300
	1075 JT	750	715 - 760	700 - 745	635	80	325
	1080 JT	800	765 - 810	750 - 795	685	80	350
	1082 JT		800 - 845	785 - 830	720	80	385
	1090 JT	900	865 - 910	850 - 895	785	80	400
	1092 JT		900 - 945	885 - 930	820	80	435
	1100 JT	1000	965 - 1010	950 - 995	885	80	450
	1102 JT		1000 - 1045	985 - 1030	920	80	485
	1120 JT	1200	1165 - 1210	1150 - 1195	1085	80	550

* Il vetro GH non è reversibile, si prega di indicare il lato di montaggio / Die Glasart GH ist nicht reversibel, bitte Montageseite angeben
The glass GH is not reversible, please specify the mounting side / El vidrio GH no es reversible, por favor indique lado de montaje

<p>Laterale con sostegno Seitenteil mit Stütze Side panel with support Pared lateral con soporte</p>	0070 JW	700	665 - 710	650 - 695			
	0075 JW	750	715 - 760	700 - 745			
	0080 JW	800	765 - 810	750 - 795			
	0082 JW		800 - 845	785 - 830			
	0090 JW	900	865 - 910	850 - 895			
	0092 JW		900 - 945	885 - 930			
	0100 JW	1000	965 - 1010	950 - 995			
	0102 JW		1000 - 1045	985 - 1030			
	0120 JW	1200	1165 - 1210	1150 - 1195			

