

WHITE



BLACK



SILVER



GLAX 1 2.0 | FINISHES

	PROFILE	GRIFFE	PANEEL	ABLAGE	RÜCKWÄNDE	DUSCHWANNE	DACH *	KLAPPSITZ *
WHITE	Weiß Matt	Weiß Matt	Weiß Matt	Weiß Matt	Weiß	Weiß Glanz	Weiß Matt	Weiß
BLACK	Schwarz Matt	Schwarz Matt	Schwarz Matt	Schwarz Matt	Weiß	Weiß Glanz	Weiß Matt	Weiß
SILVER	Silber	Chrom	Silber	Chrom	Weiß	Weiß Glanz	Weiß Matt	Weiß

* je nach Ausstattungsvariante

GLAX 1 2.0 | FUNKTIONEN UND AUSTRÜSTUNG (je nach Version verfügbar)



-   Mechanische Armatur oder Thermostatarmatur
-   Kopfbrause
-  Ablage
-  Bluetooth
-  Klappbarer Sitz
-  Elektronisches Bedienelement Soft-Touch
-   Farblicht (Version Dampfbad Basic)
LED Beleuchtung (Version Standard mit Dach, mit LED Licht)
-  Dampfbad+ Aromadisenser für Duftessenzen

GLAX 1 2.0 G+F



MULTIFUNKTIONSKABINE G+F DREHTÜR + SEITENWAND

Design Marco Pellici

Maße				Code	Ausführung		Armatur		Glas	Farbe		
Maße (cm)	Brausetasse (cm)	Höhe Kabine (cm)	Einstiegsbreite		D	S	M	T	1	UU	HH	BB
		C	*		Rechts	Links	Mechanisch	Thermostat	ESG-Klar	White	Black	Silver
STANDARD												
					D	S	M-	T-	1	UU	HH	BB
80 X 80	4,5	210	61	G21GF80								
80 X 80	11,5	217	61	G21GF89								
90 X 90	4,5	210	71	G21GF90								
90 X 90	11,5	217	71	G21GF99								
STANDARD MIT DACH												
					D	S	MF-	TF-	1	UU	HH	BB
80 X 80	4,5	217	61	G21GF80								
80 X 80	11,5	224	61	G21GF89								
90 X 90	4,5	217	71	G21GF90								
90 X 90	11,5	224	71	G21GF99								
STANDARD MIT DACH UND LED LICHT												
					D	S	MFL-	TFL-	1	UU	HH	BB
80 X 80	4,5	217	61	G21GF80								
80 X 80	11,5	224	61	G21GF89								
90 X 90	4,5	217	71	G21GF90								
90 X 90	11,5	224	71	G21GF99								
DAMPFBAD												
					D	S	M5-	T5-	1	UU	HH	BB
80 X 80	4,5	217	61	G21GF80								
80 X 80	11,5	224	61	G21GF89								
90 X 90	4,5	217	71	G21GF90								
90 X 90	11,5	224	71	G21GF99								

SONDERAUSSTATTUNG

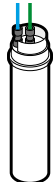
Flexibler Abflussschlauch		Wasserenthärter für Dampfgenerator S.350	
			
Code	Preis	Code	Preis
RISCCAB		R90FLTATC01	



GLAX 1.2.0 G BLACK

GLAX 1.2.0

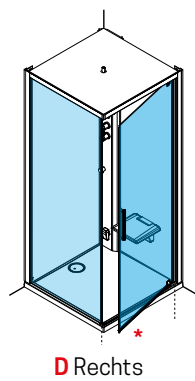
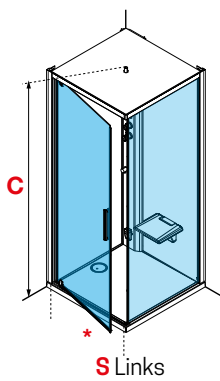

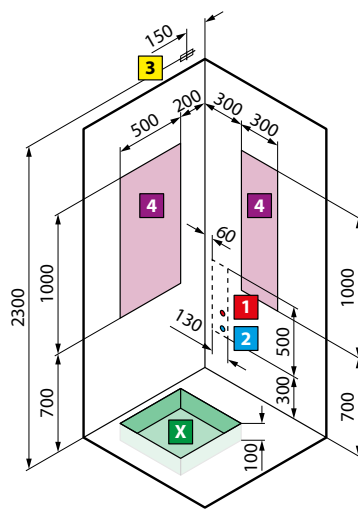
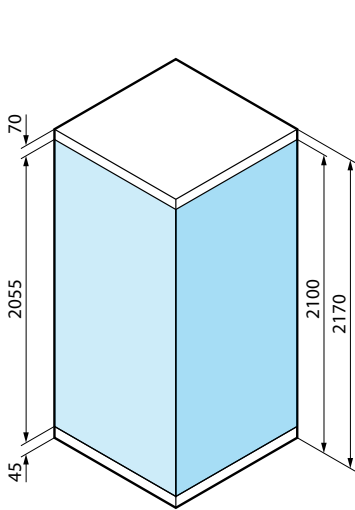

für Modelle
**A80 - A90 - A100 - GF80 -
GF90 - R90 - R100**

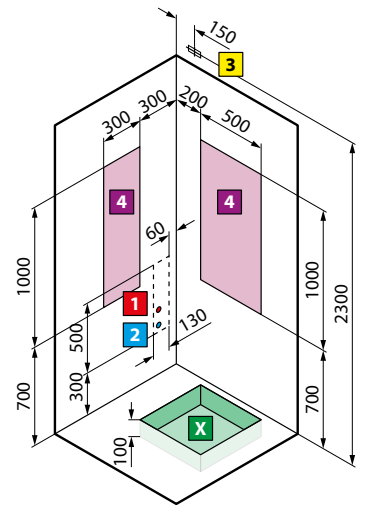
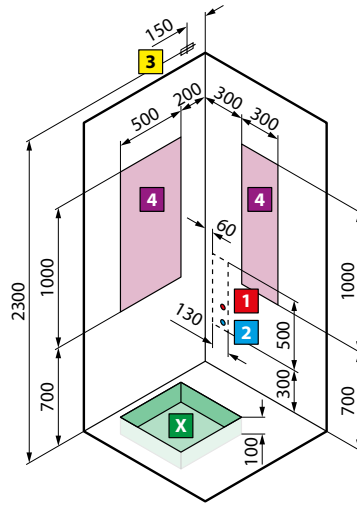

Version Rechts **Version Links**
für mod. **A90x70 - A100x70 - A100x80 -
2P 120x80 - 2P 120x90**

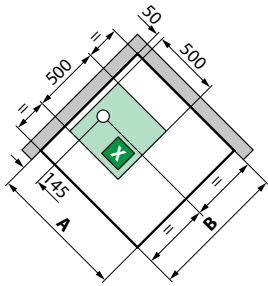

Modelle	A ± 3	B ± 3
A80	796	796
A90	896	896
A 100	996	996
GF80	796	796
GF90	896	896

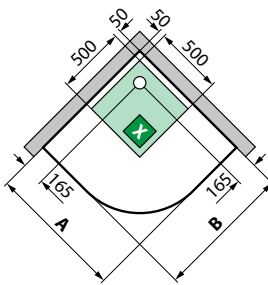

Modelle	A ± 3	B ± 3
R90	896	896
R100	996	996

S LINKS

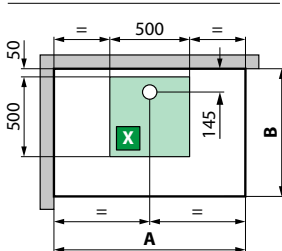

D RECHTS

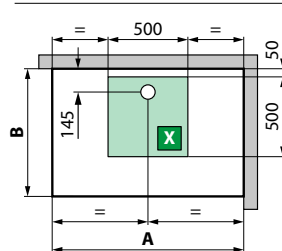

Modelle	A ± 3	B ± 3
A90x70	896	696
A100x70	996	696
A100x80	996	796
2P120x80	1196	796
2P120x90	1196	896

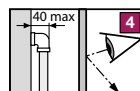
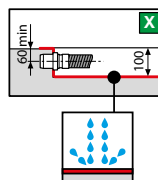
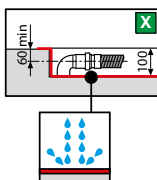

Brausetasse ohne
Inspektionspaneel



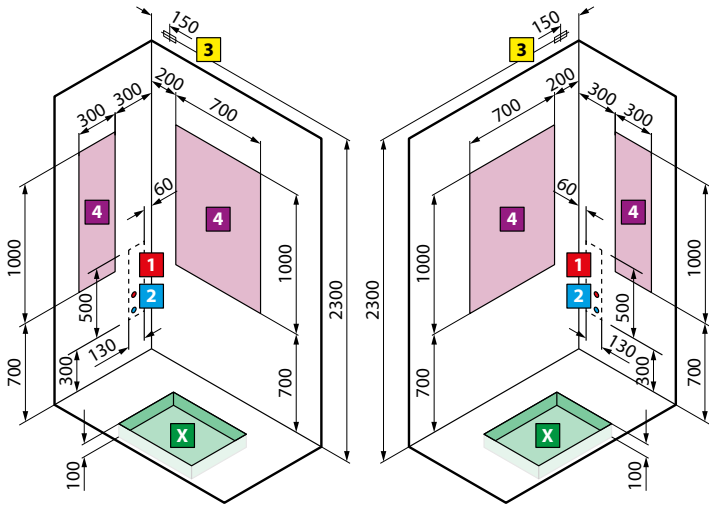

Version **Links**

Version **Rechts**

für mod. **2P140x80 - 2P140x90**

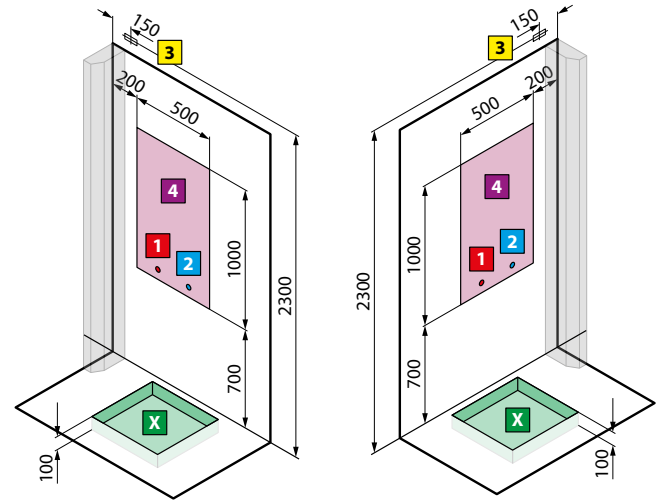

Version **Links**

Version **Rechts**

für mod. **A100x80**

für mod. **A100x80 - 2P120x80**

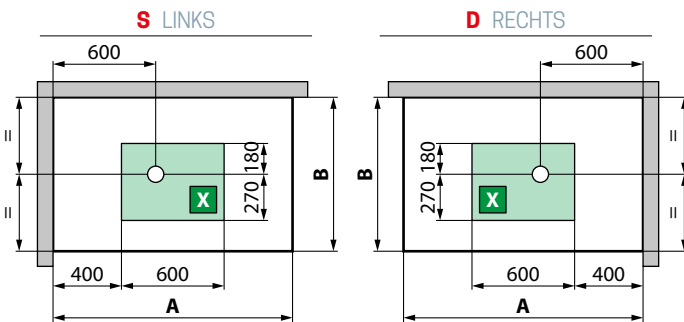

Modelle	A ± 3	B ± 3
2P140x80	1394	794
2P140x90	1394	894

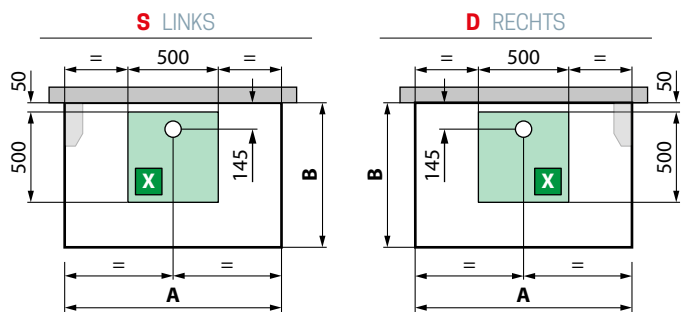

Modelle	A ± 3	B ± 3
A+F100x80	996	796
2P+2F120x80	1196	796

TECHNISCHE EIGENSCHAFTEN:
 Optimaler dynamischer Druck 2÷5 bar
 Warmwasseranschluss 1/2"
 Kaltwasseranschluss 1/2"
 Syphonanschluss ø 40 mm

ELEKTRISCHE ANSCHLUSSWERTE:
 Spannung 220 - 230 V
 Frequenz 50/60 Hz
 Max. Leistungsaufnahme: 2600 W
 Nennleistung: 2500 W

ACHTUNG! Vor der Installation der elektrischen Anlage muss ein 30mA Differentialschalter mit allpoliger Schaltereinheit eingebaut werden, mit einer Öffnung der Kontakte von mindestens 3 mm.

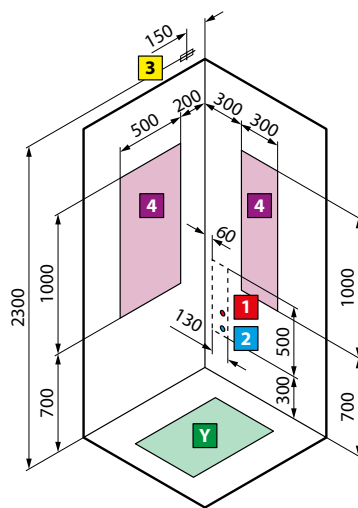
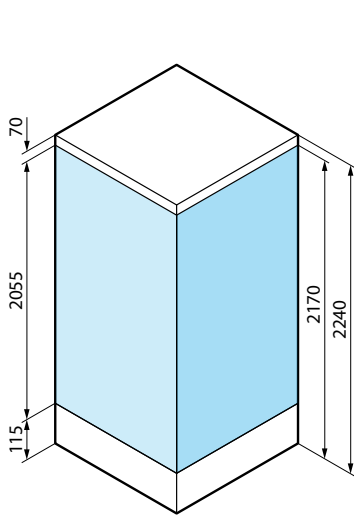

für Modelle
**A80 - A90 - A100 - GF80 -
GF90 - R90 - R100**

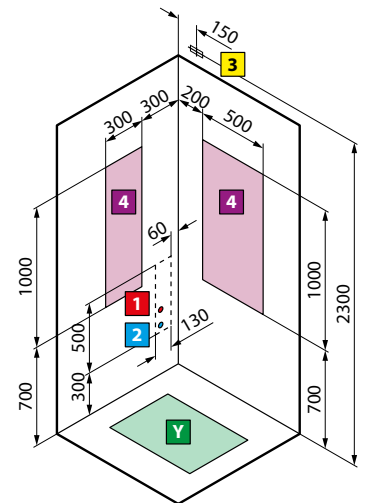
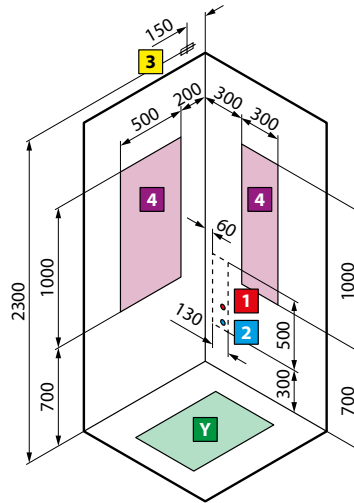

Version Rechts **Version Links**
für mod. **A90x70 - A100x70 - A100x80 -
2P 120x80 - 2P 120x90**

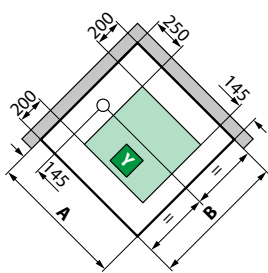

Modelle	A ± 3	B ± 3
A80	796	796
A90	896	896
A 100	996	996
GF80	796	796
GF90	896	896

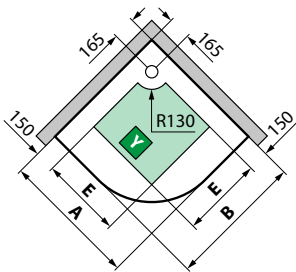

Modelle	A ± 3	B ± 3
R90	896	896
R100	996	996

S LINKS

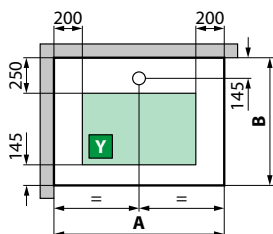

D RECHTS

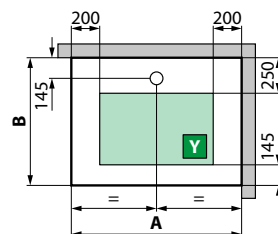

Modelle	A ± 3	B ± 3
A90x70	896	696
A100x70	996	696
A100x80	996	796
2P120x80	1196	796
2P120x90	1196	896

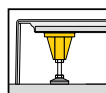
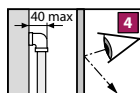
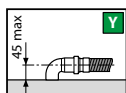

Brausetasse ohne
Inspektionspaneel

ACHTUNG!
Kann für Personen
mit Herzschrittmacher
gefährlich sein.

GLAX 2.0 DUSCHWANNEN 125 MM TECHNISCHE SKIZZEN

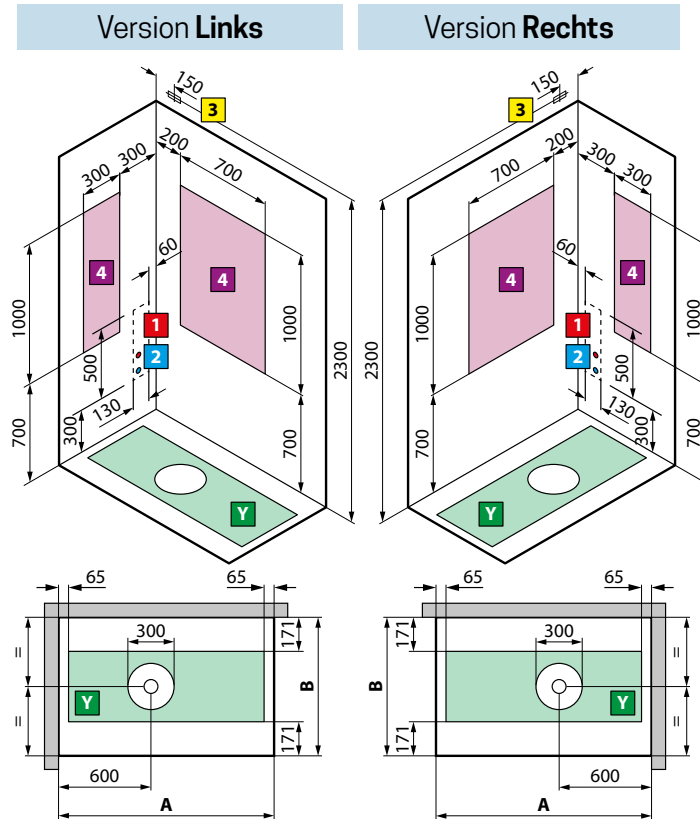
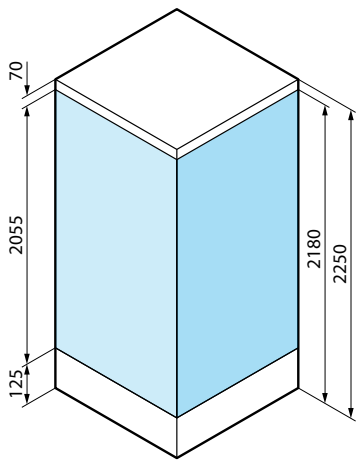

Modelle	A ± 3	B ± 3
2P140x80	1398	798
2P140x90	1398	898

GLAX 2.0 DUSCHWANNEN 115 MM

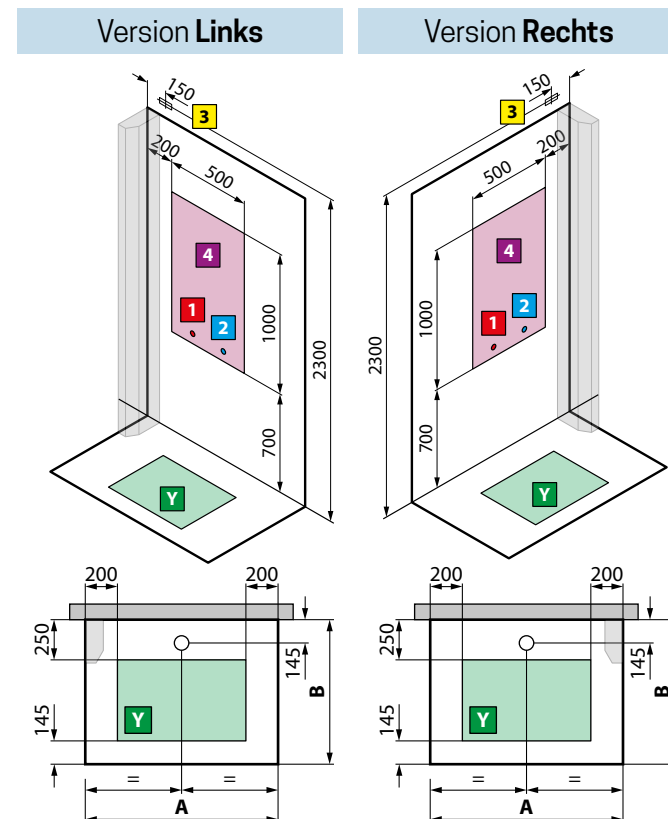
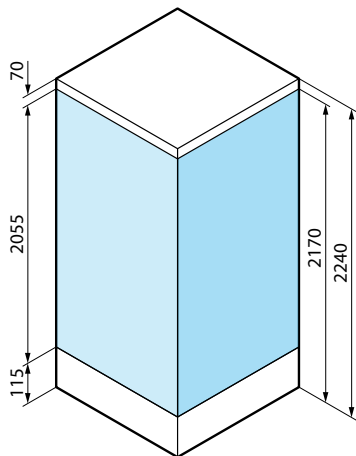

Modelle	A ± 4	B ± 4
A+F100x80	998	798
2P+2F120x80	1198	798

TECHNISCHE EIGENSCHAFTEN:
 Optimaler dynamischer Druck 2-5 bar
 Warmwasseranschluss 1/2"
 Kaltwasseranschluss 1/2"
 Syphonanschluss ø 40 mm

ELEKTRISCHE ANSCHLUSSWERTE:
 Spannung 220 - 230 V
 Frequenz 50/60 Hz
 Max. Leistungsaufnahme: 2600 W
 Nennleistung: 2500 W

ACHTUNG! Vor der Installation der elektrischen Anlage muss ein 30mA Differentialschalter mit allpoliger Schaltereinheit eingebaut werden, mit einer Öffnung der Kontakte von mindestens 3 mm.