

WHITE



BLACK



SILVER



GLAX 1 2.0 | FINISHES

	PROFILE	GRIFFE	PANEEL	ABLAGE	RÜCKWÄNDE	DUSCHWANNE	DACH *	KLAPPSITZ *
WHITE	Weiß Matt	Weiß Matt	Weiß Matt	Weiß Matt	Weiß	Weiß Glanz	Weiß Matt	Weiß
BLACK	Schwarz Matt	Schwarz Matt	Schwarz Matt	Schwarz Matt	Weiß	Weiß Glanz	Weiß Matt	Weiß
SILVER	Silber	Chrom	Silber	Chrom	Weiß	Weiß Glanz	Weiß Matt	Weiß

* je nach Ausstattungsvariante

GLAX 1 2.0 | FUNKTIONEN UND AUSTRÜSTUNG (je nach Version verfügbar)



-   Mechanische Armatur oder Thermostatarmatur
-   Kopfbrause
-  Ablage
-  Bluetooth
-  Klappbarer Sitz
-  Elektronisches Bedienelement Soft-Touch
-   Farblicht (Version Dampfbad Basic)
LED Beleuchtung (Version Standard mit Dach, mit LED Licht)
-  Dampfbad+ Aromadisenser für Duftessenzen

GLAX 12.0 A



MULTIFUNKTIONSKABINE A ECKEINSTIEG MIT SCHIEBETÜREN

Design Marco Pellici

Maße				Code	Ausführung		Armatur		Glas	Farbe		
Maße (cm)	Brausetasse (cm)	Höhe Kabine (cm)	Einstiegsbreite		D	S	M	T	1	UU	HH	BB
		C	*		Rechts	Links	Mechanisch	Thermostat	ESG-Klar	White	Black	Silver

STANDARD

					D	S	M-	T-	1	UU	HH	BB
80 X 80	4,5	210	40	G21A80								
80 X 80	11,5	217	40	G21A89								
90 X 90	4,5	210	47	G21A90								
90 X 90	11,5	217	47	G21A99								
100 X 100	4,5	210	54	G21A100								
100 X 100	11,5	217	54	G21A109								
90 X 70	4,5	210	40	G21A9070								
90 X 70	11,5	217	40	G21A9079								
100 X 70	4,5	210	43,5	G21A107								
100 X 70	11,5	217	43,5	G21A197	•	•		•	•			
100 X 80	4,5	210	47,5	G21A108				•	•			
100 X 80	11,5	217	47,5	G21A198	•	•		•	•			

STANDARD MIT DACH

					D	S	MF-	TF-	1	UU	HH	BB
80 X 80	4,5	217	40	G21A80								
80 X 80	11,5	224	40	G21A89								
90 X 90	4,5	217	47	G21A90								
90 X 90	11,5	224	47	G21A99								
100 X 100	4,5	217	54	G21A100								
100 X 100	11,5	224	54	G21A109								
90 X 70	4,5	217	40	G21A9070								
90 X 70	11,5	224	40	G21A9079								
100 X 70	4,5	217	43,5	G21A107								
100 X 70	11,5	224	43,5	G21A197	•	•		•	•			
100 X 80	4,5	217	47,5	G21A108				•	•			
100 X 80	11,5	224	47,5	G21A198	•	•		•	•			

STANDARD MIT DACH UND LED LICHT

					D	S	MFL-	TFL-	1	UU	HH	BB
80 X 80	4,5	217	40	G21A80								
80 X 80	11,5	224	40	G21A89								
90 X 90	4,5	217	47	G21A90								
90 X 90	11,5	224	47	G21A99								
100 X 100	4,5	217	54	G21A100								
100 X 100	11,5	224	54	G21A109								
90 X 70	4,5	217	40	G21A9070								
90 X 70	11,5	224	40	G21A9079								
100 X 70	4,5	217	43,5	G21A107								
100 X 70	11,5	224	43,5	G21A197								
100 X 80	4,5	217	47,5	G21A108								
100 X 80	11,5	224	47,5	G21A198								

DAMPFBAD

					D	S	M5-	T5-	1	UU	HH	BB
80 X 80	4,5	217	40	G21A80								
80 X 80	11,5	224	40	G21A89								
90 X 90	4,5	217	47	G21A90								
90 X 90	11,5	224	47	G21A99								
100 X 100	4,5	217	54	G21A100								
100 X 100	11,5	224	54	G21A109								
90 X 70	4,5	217	40	G21A9070								
90 X 70	11,5	224	40	G21A9079								
100 X 70	4,5	217	43,5	G21A107								
100 X 70	11,5	224	43,5	G21A197	•	•		•	•			
100 X 80	4,5	217	47,5	G21A108								
100 X 80	11,5	224	47,5	G21A198	•	•		•	•			





GLAX 1.2.0 A SILVER

80x80 | 90x90 | 100x100

90x70 | 100x70 | 100x80

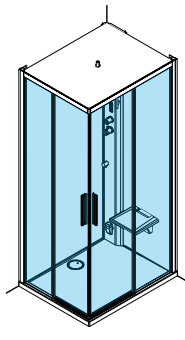
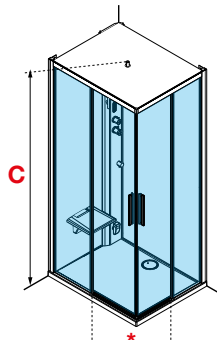
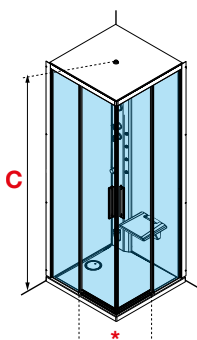

S Links

D Rechts

SONDERAUSSTATTUNG

Flexibler Abflussschlauch



Code	Preis
RISCCAB	

Wasserenthärter für Dampfgenerator S.350



Code	Preis
R90FLTATC01	

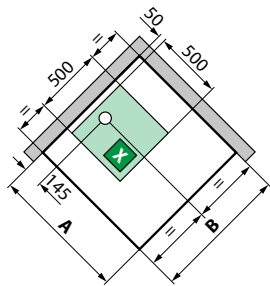
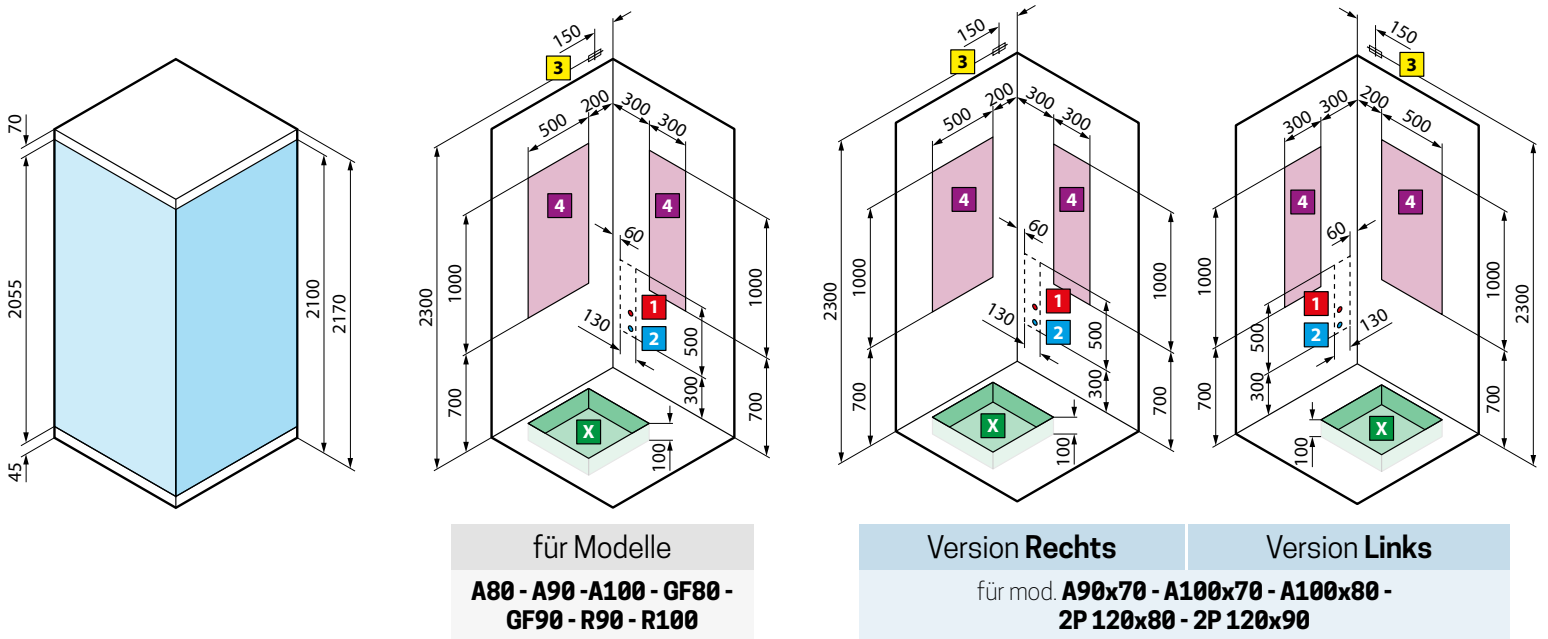

Modelle	A ± 3	B ± 3
A80	796	796
A90	896	896
A 100	996	996
GF80	796	796
GF90	896	896

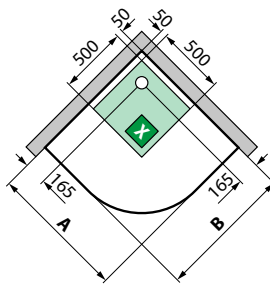

Modelle	A ± 3	B ± 3
R90	896	896
R100	996	996

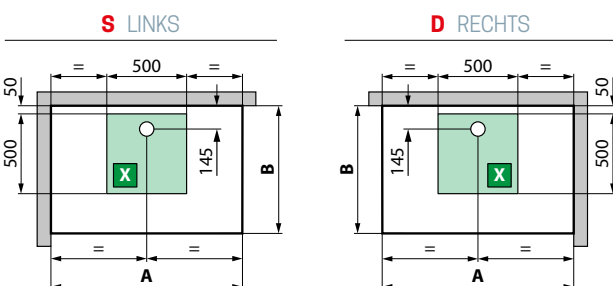

Modelle	A ± 3	B ± 3
A90x70	896	696
A100x70	996	696
A100x80	996	796
2P120x80	1196	796
2P120x90	1196	896

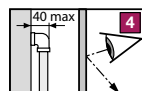
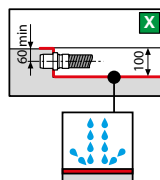
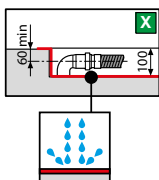

Brausetasse ohne Inspektionspaneel

ACHTUNG!
Kann für Personen mit Herzschrittmacher gefährlich sein.

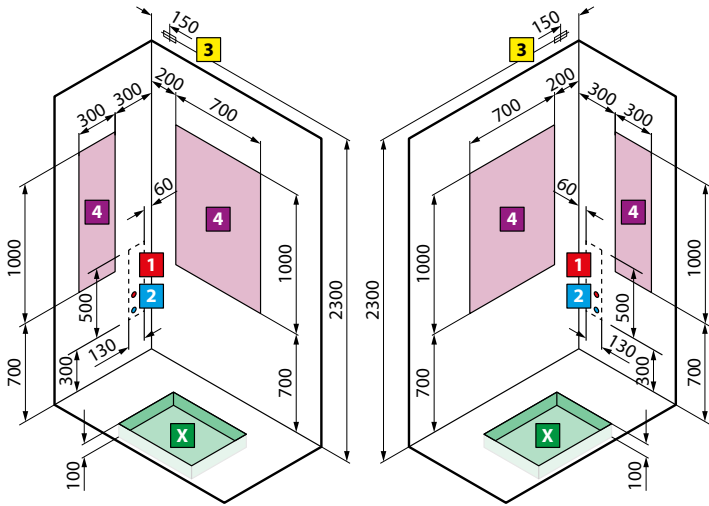

Version **Links**

Version **Rechts**

für mod. **2P140x80 - 2P140x90**

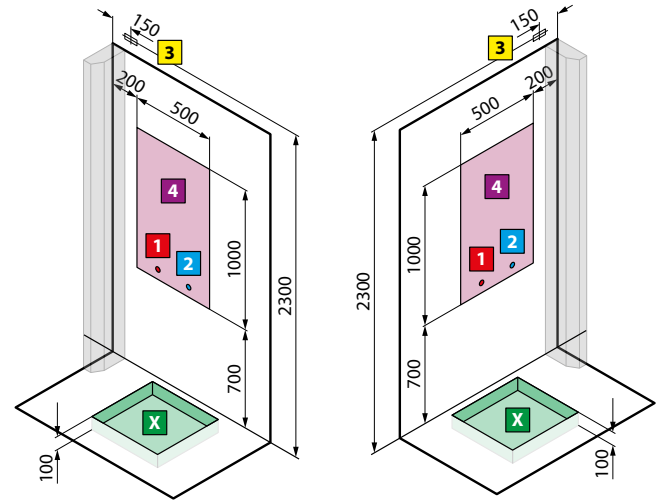

Version **Links**

Version **Rechts**

für mod. **A100x80**

für mod. **A100x80 - 2P120x80**

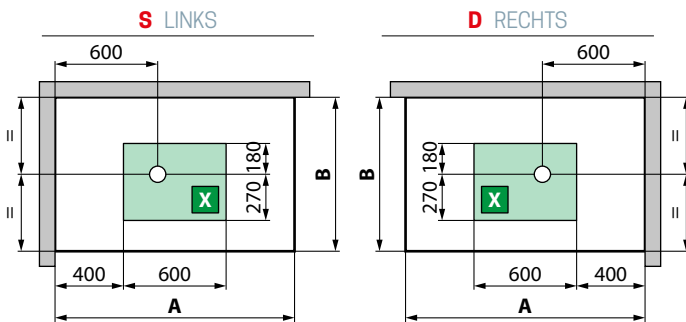

Modelle	A ± 3	B ± 3
2P140x80	1394	794
2P140x90	1394	894

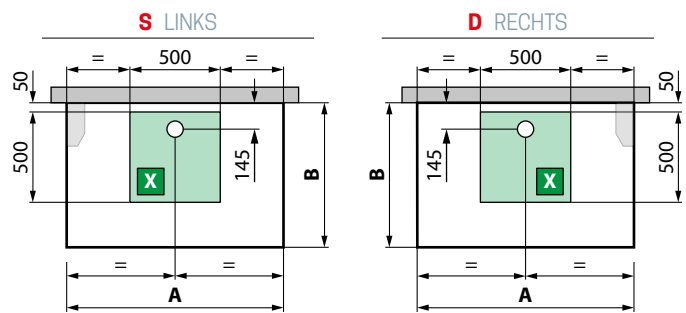

Modelle	A ± 3	B ± 3
A+F100x80	996	796
2P+2F120x80	1196	796

TECHNISCHE EIGENSCHAFTEN:
 Optimaler dynamischer Druck 2÷5 bar
 Warmwasseranschluss 1/2"
 Kaltwasseranschluss 1/2"
 Syphonanschluss ø 40 mm

ELEKTRISCHE ANSCHLUSSWERTE:
 Spannung 220 - 230 V
 Frequenz 50/60 Hz
 Max. Leistungsaufnahme: 2600 W
 Nennleistung: 2500 W

ACHTUNG! Vor der Installation der elektrischen Anlage muss ein 30mA Differentialschalter mit allpoliger Schaltereinheit eingebaut werden, mit einer Öffnung der Kontakte von mindestens 3 mm.

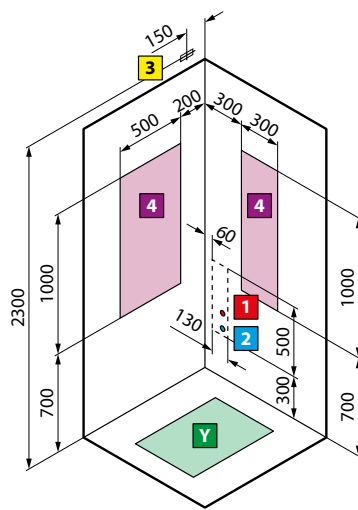
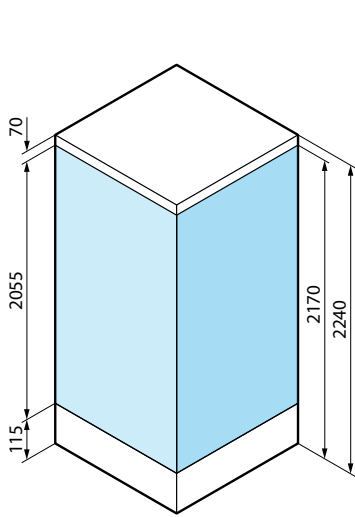

für Modelle
**A80 - A90 - A100 - GF80 -
GF90 - R90 - R100**

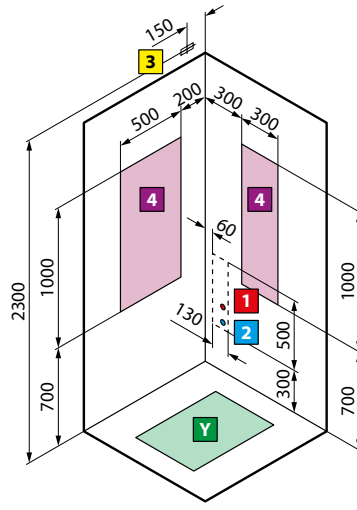

Version **Rechts** Version **Links**
für mod. **A90x70 - A100x70 - A100x80 -
2P 120x80 - 2P 120x90**

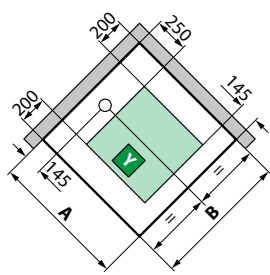
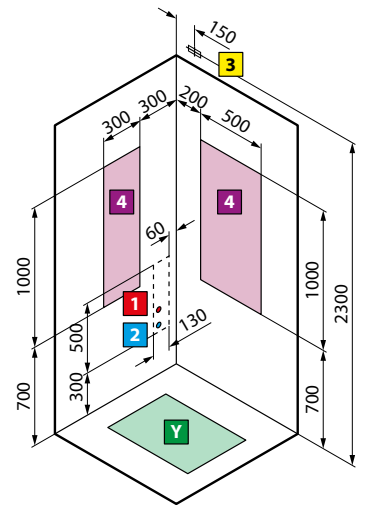

Modelle	A ± 3	B ± 3
A80	796	796
A90	896	896
A 100	996	996
GF80	796	796
GF90	896	896

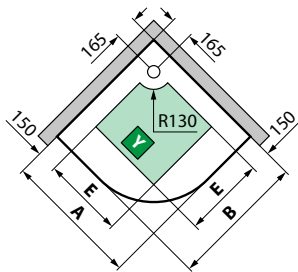

Modelle	A ± 3	B ± 3
R90	896	896
R100	996	996

S LINKS

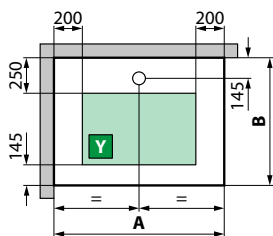

D RECHTS

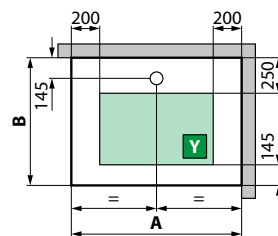

Modelle	A ± 3	B ± 3
A90x70	896	696
A100x70	996	696
A100x80	996	796
2P120x80	1196	796
2P120x90	1196	896

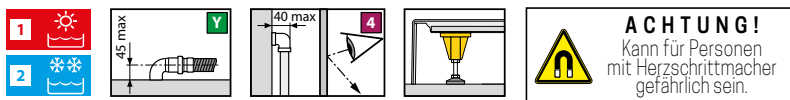

Brausetasse ohne
Inspektionspaneel

ACHTUNG!
Kann für Personen
mit Herzschrittmacher
gefährlich sein.

GLAX 2.0 DUSCHWANNEN 125 MM TECHNISCHE SKIZZEN

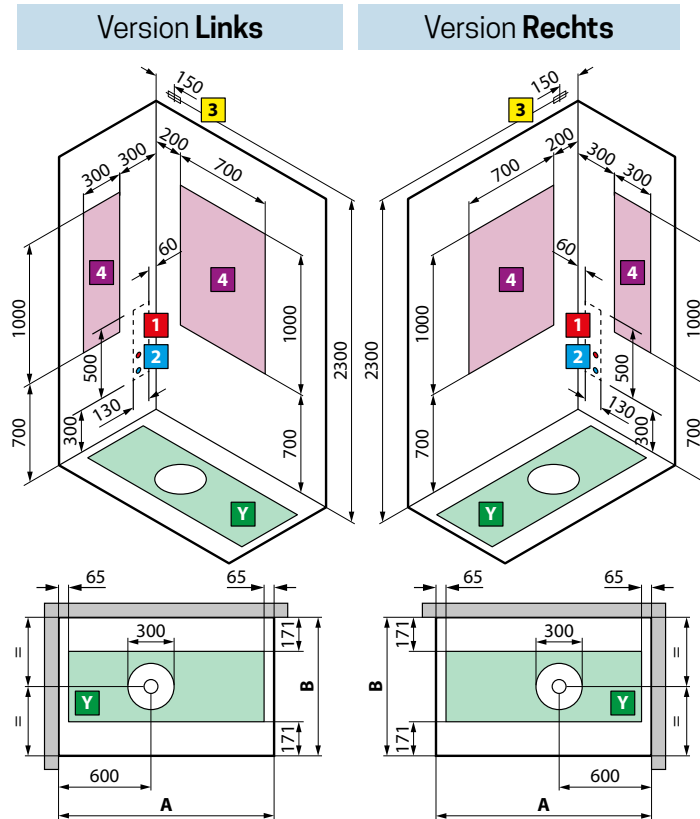
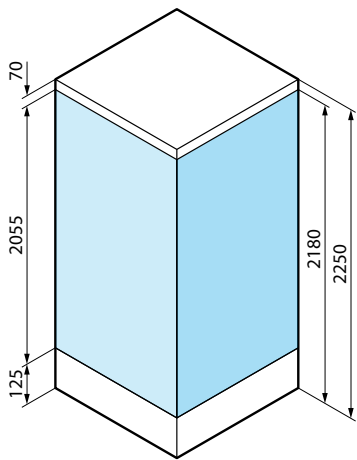

Modelle	A ± 3	B ± 3
2P140x80	1398	798
2P140x90	1398	898

GLAX 2.0 DUSCHWANNEN 115 MM

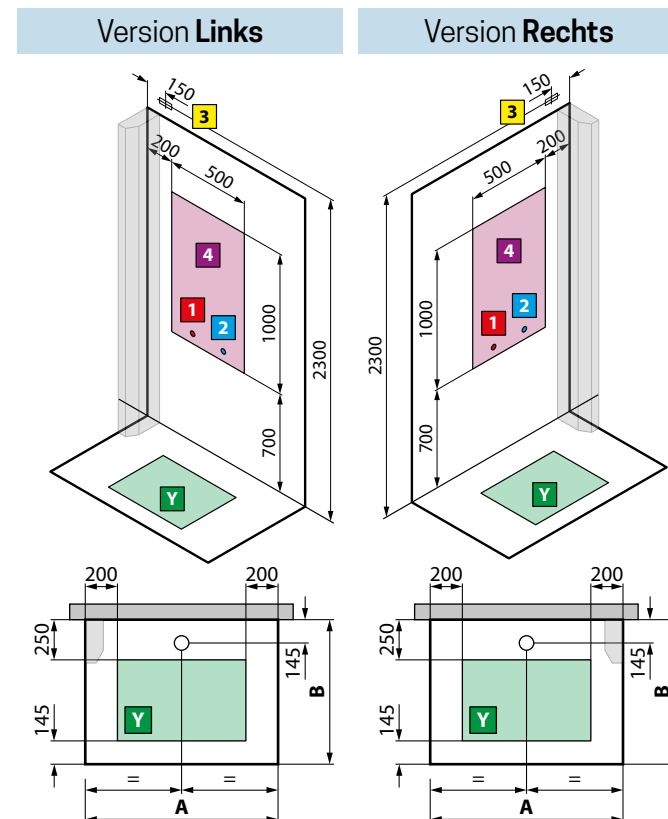
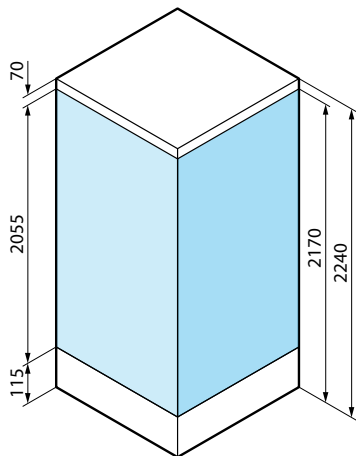

Modelle	A ± 4	B ± 4
A+F100x80	998	798
2P+2F120x80	1198	798

TECHNISCHE EIGENSCHAFTEN:
 Optimaler dynamischer Druck 2-5 bar
 Warmwasseranschluss 1/2"
 Kaltwasseranschluss 1/2"
 Syphonanschluss ø 40 mm

ELEKTRISCHE ANSCHLUSSWERTE:
 Spannung 220 - 230 V
 Frequenz 50/60 Hz
 Max. Leistungsaufnahme: 2600 W
 Nennleistung: 2500 W

ACHTUNG! Vor der Installation der elektrischen Anlage muss ein 30mA Differentialschalter mit allpoliger Schaltereinheit eingebaut werden, mit einer Öffnung der Kontakte von mindestens 3 mm.